

NETWORK CAMERA

USER'S MANUAL

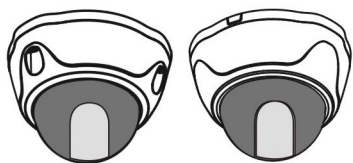

WARNING

**RISK OF ELECTRIC SHOCK
DO NOT OPEN**

WARNING: TO REDUCE THE RISK OF ELECTRIC SHOCK,
DO NOT REMOVE COVER (OR BACK).
NO USER-SERVICEABLE PARTS INSIDE.
REFER SERVICING TO QUALIFIED
SERVICE PERSONNEL.

COMPLIANCE NOTICE OF FCC:

THIS EQUIPMENT HAS BEEN TESTED AND FOUND TO COMPLY WITH THE LIMITS FOR A CLASS A DIGITAL DEVICE, PURSUANT TO PART 15 OF THE FCC RULES. THESE LIMITS ARE DESIGNED TO PROVIDE REASONABLE PROTECTION AGAINST HARMFUL INTERFERENCE WHEN THE EQUIPMENT IS OPERATED IN A COMMERCIAL ENVIRONMENT. THIS EQUIPMENT GENERATES, USES, AND CAN RADIATE RADIO FREQUENCY ENERGY AND IF NOT INSTALLED AND USED IN ACCORDANCE WITH THE INSTRUCTION MANUAL, MAY CAUSE HARMFUL INTERFERENCE TO RADIO COMMUNICATIONS. OPERATION OF THIS EQUIPMENT IN A RESIDENTIAL AREA IS LIKELY TO CAUSE HARMFUL INTERFERENCE, IN WHICH CASE USERS WILL BE REQUIRED TO CORRECT THE INTERFERENCE AT THEIR OWN EXPENSE.

WARNING: CHANGES OR MODIFICATIONS NOT EXPRESSLY APPROVED BY THE PARTY RESPONSIBLE FOR COMPLIANCE COULD VOID THE USER'S AUTHORITY TO OPERATE THE EQUIPMENT.

THIS CLASS OF DIGITAL APPARATUS MEETS ALL REQUIREMENTS OF THE CANADIAN INTERFERENCE-CAUSING EQUIPMENT REGULATIONS.

The information in this manual is believed to be accurate as of the date of publication. We are not responsible for any problems resulting from the use thereof. The information contained herein is subject to change without notice. Revisions or new editions to this publication may be issued to incorporate such changes.

The software included in this product contains some Open Sources. You may obtain the complete corresponding source code from us. See the Open Source Guide on the software CD (OpenSourceGuide\OpenSourceGuide.pdf) or as a printed document included along with the User's Manual.

WEEE (Waste Electrical & Electronic Equipment)**Correct Disposal of This Product**

(Applicable in the European Union and other European countries with separate collection systems)



This marking shown on the product or its literature, indicates that it should not be disposed with other household wastes at the end of its working life. To prevent possible harm to the environment or human health from uncontrolled waste disposal, please separate this from other types of wastes and recycle it responsibly to promote the sustainable reuse of material resources.

Household users should contact either the retailer where they purchased this product, or their local government office, for details of where and how they can take this item for environmentally safe recycling.

Business users should contact their supplier and check the terms and conditions of the purchase contract. This product should not be mixed with other commercial wastes for disposal.

Important Safeguards

1. Read Instructions

All the safety and operating instructions should be read before the appliance is operated.

2. Retain Instructions

The safety and operating instructions should be retained for future reference.

3. Cleaning

Unplug this equipment from the wall outlet before cleaning it. Do not use liquid aerosol cleaners. Use a damp soft cloth for cleaning.

4. Attachments

Never add any attachments and/or equipment without the approval of the manufacturer as such additions may result in the risk of fire, electric shock or other personal injury.

5. Water and/or Moisture

Do not use this equipment near water or in contact with water.

6. Placing and Accessories

Do not place this equipment on an wall or ceiling that is not strong enough to sustain the camera. The equipment may fall, causing serious injury to a child or adult, and serious damage to the equipment. Wall or shelf mounting should follow the manufacturer's instructions, and should use a mounting kit approved by the manufacturer.



This equipment and cart combination should be moved with care. Quick stops, excessive force, and uneven surfaces may cause the equipment and cart combination to overturn.

Do not place this equipment in an enclosed space. Sufficient ventilation is required to prevent an increase in ambient temperature which can cause malfunction or the risk of fire.

7. Power Sources

This equipment should be operated only from the type of power source indicated on the marking label. If you are not sure of the type of power, please consult your equipment dealer or local power company.

8. Power Cord

Operator or installer must remove power and TNT connections before handling the equipment.

9. Lightning

For added protection for this equipment during a lightning storm, or when it is left unattended and unused for long periods of time, unplug it from the wall outlet and disconnect the antenna or cable system. This will prevent damage to the equipment due to lightning and power-line surges. If thunder or lightning is common where the equipment is installed, use a surge protection device.

10. Overloading

Do not overload wall outlets and extension cords as this can result in the risk of fire or electric shock.

11. Objects and Liquids

Never push objects of any kind through openings of this equipment as they may touch dangerous voltage points or short out parts that could result in a fire or electric shock. Never spill liquid of any kind on the equipment.

12. Servicing

Do not attempt to service this equipment yourself. Refer all servicing to qualified service personnel.

13. Damage requiring Service

Unplug this equipment from the wall outlet and refer servicing to qualified service personnel under the following conditions:

- A. When the power-supply cord or the plug has been damaged.
- B. If liquid is spilled, or objects have hit the equipment.
- C. If the equipment has been exposed to rain or water.
- D. If the equipment does not operate normally by following the operating instructions, adjust only those controls that are covered by the operating instructions as an improper adjustment of other controls may result in damage and will often require extensive work by a qualified technician to restore the equipment to its normal operation.
- E. If the equipment has been dropped, or the cabinet damaged.
- F. When the equipment exhibits a distinct change in performance — this indicates a need for service.

14. Replacement Parts

When replacement parts are required, be sure the service technician has used replacement parts specified by the manufacturer or that have the same characteristics as the original part. Unauthorized substitutions may result in fire, electric shock or other hazards.

15. Safety Check

Upon completion of any service or repairs to this equipment, ask the service technician to perform safety checks to determine that the equipment is in proper operating condition.

16. Field Installation

This installation should be made by a qualified service person and should conform to all local codes.

17. Correct Batteries

Warning: Risk of explosion if battery is replaced by an incorrect type. Dispose of used batteries according to the instructions.

18. Tmra

A manufacturer's maximum recommended ambient temperature (Tmra) for the equipment must be specified so that the customer and installer may determine a suitable maximum operating environment for the equipment.

Risk Group 1



WARNING: IR emitted from this product. Do not stare at operating lamp

Product tested against IEC62471

WARNING: IR (Infrared Radiation) is emitted from this product. Do NOT stare at the IR LED.

Table of Contents

Chapter 1 — Introduction	1
In This Manual	1
Features	1
Typical Applications	2
Remote Monitoring	2
Remote Recording	3
Webcasting	3
Chapter 2 — Installation	5
Package Contents	5
Dimensions	5
Illustrated Parts List	5
Vandal Dome Model	5
Plastic Dome Model	6
Factory Reset	8
Lens	8
Input/Output Device Ports	9
Mounting	10
View Angle	11
Chapter 3 — Remote Setup	13
Quick Setup	14
System	14
General	14
Date/Time	15
User/Group	16
Network	17
IP Address	18
DVRNS	19
Port/QoS	20
Bandwidth Control	22
Security	23
IEEE 802.1X	24
Video	25
Camera	25
Streaming	31
Webcasting	33
MAT	34
Privacy Masking	35
Audio	36
Input/Output	36

Event Action	37
Alarm Out	37
Email	38
Remote Callback	39
Audio Alarm	40
FTP Upload	41
Record	42
Event	45
Alarm In	46
Motion Detection	47
Trip-Zone	49
Audio Detection	50
Tampering	51
System Event	52
Chapter 4 — WebGuard	55
Web Monitoring Mode	57
Web Search Mode	59
Appendix	61
LED Indicators	61
Connector Pin Outs	61
Map of Screens (Remote Setup)	62
Troubleshooting	63
Specifications	63
Index	67

Chapter 1 — Introduction

In This Manual

This manual is intended for users of the network camera and includes instructions for using and managing the camera on the network.

Features

This network camera compresses live video and transmits the video over Ethernet connections. The camera can be accessed, configured and managed by using the INIT (Integrated Network Installation Tool) program. It has a built-in web server, WebGuard, allowing you to monitor live video and search recorded video remotely using a web browser. The remote programs provided with the camera also allow remote management, monitoring, searching and recording. This camera offers the following features:

- Multistream for live monitoring and recording
- H.264 and M-JPEG compression algorithm
- Four levels of video compression and various video compression resolutions
- Two-way audio communication
- Pre- and post-event buffering and video stream buffering to enhance reliability of network recording
- Remote monitoring via web browser or remote software
- Automatic HTML code generation for webcasting on a user's website
- Up to 10 simultaneous connections to the camera for remote monitoring
- Enhanced security using IP address filtering, HTTPS, SSL and IEEE 802.1X functions and password protected multiple user levels
- Network bandwidth limit and MAT functions to use network bandwidth efficiently
- Convenient network connection using the UPnP (Universal Plug and Play) function and built-in mDNS (Multicast DNS) protocol
- Support of the ONVIF protocol (Core specification version 1.02)
- Digital WDR (Wide Dynamic Range) to adjust the image display in high contrast conditions
- Slow shutter to reduce the minimum illumination requirements
- Day and night functionality with the built-in IR-cut filter changer
- Convenient firmware upgrades via the network connection
- Firmware duplication and autorecovery functions to enhance system stability
- Management of multiple cameras via Ethernet connections
- Event detection functions: alarm-in, motion, trip-zone, audio, tampering
- Micro SD memory recording to provide redundancy in case of network disconnection
- Power sources: 12 VDC, PoE (Power over Ethernet)
- Mega-pixel varifocal auto-iris lens included
- NTSC or PAL programmable video output
- Built-in heater allowing operation in a sub-zero temperature (only for heater supported model using 12 VDC power)

NOTES:

- In this manual, a “remote system” refers to a PC that the remote program (iNEX Basic or WebGuard) is running.
- Remote monitoring and recording through multistream are available by using the iNEX Basic program provided with the camera.

Typical Applications

Remote Monitoring

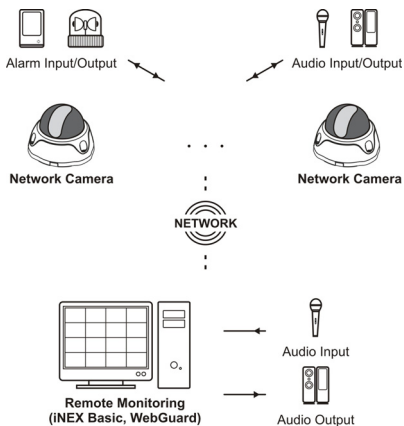

Remote Recording

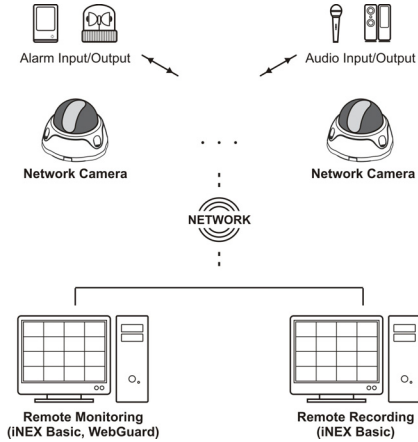

Webcasting

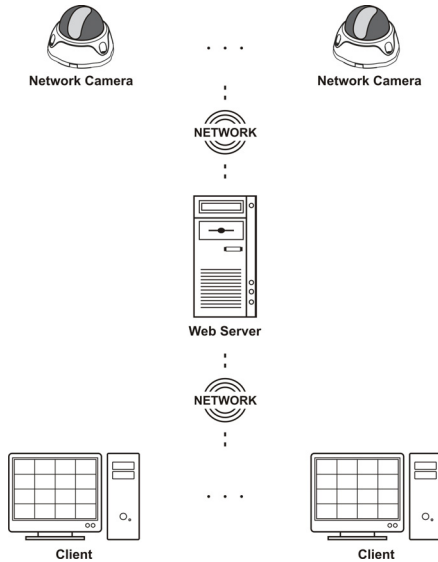

Chapter 2 — Installation

Package Contents

- Network Camera
- Installation CD (INIT/iNEX Basic software and User's Manual)
- Quick Reference Guide
- Mount Kits
- Desiccant*, Cable Access Hole Rubber*

* It is provided only for the models that support IP-66 level.

Dimensions

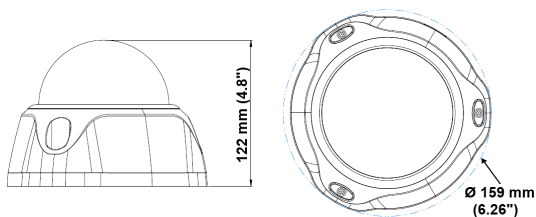

Illustrated Parts List

Vandal Dome Model

< Dome Cover >

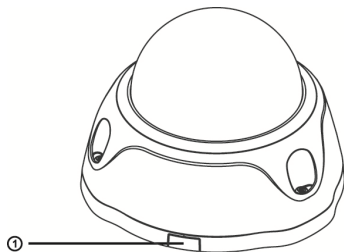

① Side Cable Access Hole

< Dome Cover – Bottom Side View >

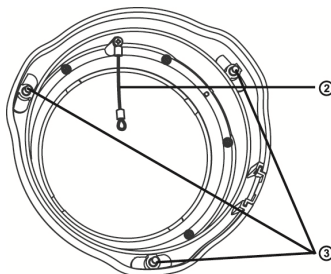

② Safety Wire

③ Dome Cover Setscrew

< Shield Case* >

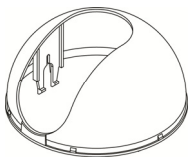

< Body >

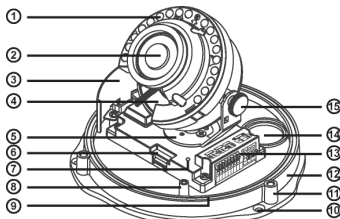

* The shield case is provided for IR LED non-supported models only.

- | | | | |
|-----------------------------|--------|------------------------------|-----------------|
| ① IR LED | ② Lens | ③ Heater | ④ Rotation Base |
| ⑤ Pan Base | | ⑥ Micro SD Memory Card Slot | |
| ⑦ Factory Reset Switch | | ⑧ Safety Wire Setscrew Hole | |
| ⑨ O-Ring Groove | | ⑩ Wall/Ceiling Mounting Hole | |
| ⑪ Dome Cover Setscrew Hole | | ⑫ Bottom Cover | |
| ⑬ Input/Output Device Ports | | ⑭ Cable Access Hole | |
| ⑮ Tilt Adjustment Screw | | | |

Plastic Dome Model

< Dome Cover >

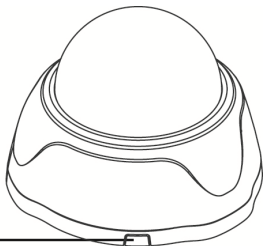

< Shield Case* >

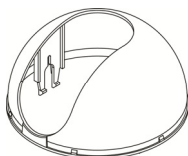

- ① Side Cable Access Hole

* The shield case is provided for IR LED non-supported models only.

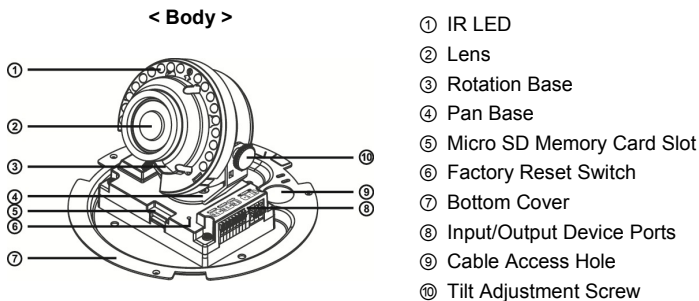

- **Side Cable Access Hole, Cable Access Hole:** Allows you to feed wires and cables for connection to power, devices, and Ethernet. If the camera is IP-66 level supported model, block the cable access hole for waterproofing by using the enclosed cable access hole rubber when routing wires and cables. Ask your dealer or distributor for details.
- **Safety Wire, Safety Wire Setscrew Hole:** Allows you to connect the safety wire to the dome cover and to the bottom cover by using the screw provided with the camera. It prevents the dome cover from falling when it is separated from the camera body.
- **Dome Cover Setscrew, Dome Cover Setscrew Hole:** Allows you to connect the dome cover to the camera body.
- **Shield Case:** Hides the inside and prevents infrared from being reflected (IR LED non-supported model only).
- **IR LED:** The sensor in the middle of IR LEDs detects low illumination and the IR LEDs are lit at night or under low lighting conditions (IR LED supported model only).
- **Lens:** Varifocal auto-iris lens is installed.
- **Heater:** Allows the camera to operate in a sub-zero temperature (Heater supported model only). It operates with 12 VDC power only.
- **Rotation Base:** Allows you to adjust the rotation angle by turning the rotation base clockwise or counterclockwise.
- **Pan Base:** Allows you to adjust the pan angle.
- **Micro SD Memory Card Slot:** Insert a micro SD memory card (SLC (Single Level Cell) or MLC (Multi Level Cell) types of SanDisk or Transcend brands recommended).
- **Factory Reset Switch:** Use to return all settings to the original factory settings. See below for details.
- **O-Ring Groove:** O-ring is seated in the groove for waterproof (IP-66 level supported model only). Do NOT remove the o-ring from the groove.
- **Wall/Ceiling Mounting Holes:** Allows you to screw the camera to the wall or ceiling.
- **Bottom Cover:** Allows you to mount the camera to the wall or ceiling.
- **Input/Output Device Ports:** Allows you to connect the input/output device. See the section below.
- **Tilt Adjustment Screw:** Allows you to adjust the tilt angle.

CAUTIONS:

- **Do NOT** remove the SD memory card while the unit is operating; otherwise, the system might not operate properly and recorded data saved on it might be damaged.
- **SD memory cards are expendable supplies.** After a certain use in time, partial memory sectors can be damaged and recording may not be available or data will be lost. Check the SD memory card periodically and replace it with a new one if necessary.

Factory Reset

This will only be used on the rare occasions that you want to return all the settings to the original factory settings.

CAUTION: When performing a Factory Reset, you will lose any settings you have saved.

Cut off the power from the camera. → Poke a straightened paperclip into the factory reset switch hole. → Turn on the power while holding the reset switch → Release the switch in about 5 seconds after the Power LED blinks. → The camera resets to factory defaults and restarts after completing the factory reset.

You can perform a factory reset while the camera is turned on by pressing the factory reset switch and releasing the reset switch. A factory reset also can be performed remotely by running the INIT program. The camera restarts after completing the factory reset. Refer to the INIT User's Manual for details on remote factory resetting.

Lens

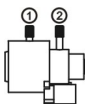

- ① **Focus Lever:** Adjust the focus by turning the lever clockwise or counterclockwise. Once it is set, twist the setscrew clockwise to lock it.
- ② **Zoom Lever:** Adjust the zoom by turning the lever clockwise or counterclockwise. Once it is set, twist the setscrew clockwise to lock it. The lever length may be different depending on model type.

Input/Output Device Ports

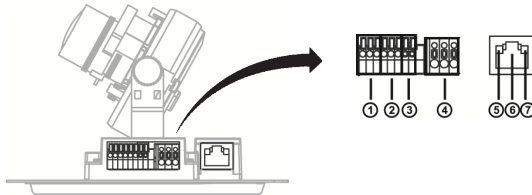

- | | | | |
|----------------|----------------|-------------|---------|
| ① Alarm In/Out | ② Audio In/Out | ③ Video Out | ④ Power |
| ⑤ Network LED | ⑥ Network Port | ⑦ Power LED | |

- **Alarm**
 - **OUT:** Connect an alarm-out device to the OUT and GND (Ground) connectors. Active Low (Open Collector output) is a relay output which sinks 30mA @ 5 VDC.
 - **IN:** Connect an alarm-in device. Mechanical or electrical switches can be wired to the IN and GND (Ground) connectors. The voltage range is from 0V to 5V. When the electrical switch is wired, the threshold voltage for NC (Normally Closed) is above 4.3V and for NO (Normally Open) is below 0.3V, and it should be stable at least 0.5 seconds to be detected.
- **Audio**
 - **OUT:** Connect to an amplifier (Line-out). The camera does not have amplified audio output, so you will need a speaker with an amplifier.
 - **IN:** Connect to an audio source (Line-in).
- **Video**
 - **CVBS, GND:** Connect two wires from the cable to the camera and the other connector from the cable to a monitor. This is intended for video preview while adjusting the camera. Configure the video signal (NTSC or PAL) for video output in Remote Setup (**System – General** menu).
- **Power**
 - **DC12V +/-:** Connect two wires from the power adapter. You must distinguish power polarity when connecting the wires. The camera starts booting as soon as power is applied.
 - **FGND (Frame GND):** Ground the camera by using the grounding cable and screw.
- **Network LED:** Indicates network connection status. See **Appendix – LED Indicators** for details. The LED will not light regardless of the status if the Status LED is disabled when configuring the **System – General** setup.
- **Network Port:** Connect a Cat5 cable with an RJ-45 connector. You can change the settings, manage the camera, upgrade the software or monitor video remotely via the network connection. Refer to the INIT User's Manual for details about network connection setup. When using a PoE switch, the camera can be supplied with power over Ethernet cable (Refer to the PoE switch manufacturer's manual for details).
- **Power LED:** Indicates system operation status. See **Appendix – LED Indicators** for details. The LED will not light regardless of the status if the Status LED is disabled when configuring the **System – General** setup.

NOTES:

- Camera and audio surveillance may be prohibited by laws that vary by region. Check the laws in your area before using this product for surveillance purposes.
- To make connections on the alarm, audio, video and power connector strip, press and hold the button and insert the wire in the hole below the button. After releasing the button, tug gently on the wire to make certain it is connected. To disconnect a wire, press and hold the button above the wire and pull out the wire.

CAUTIONS:

- The frame GND of the power should be grounded before using.
- The camera restarts after the power adaptor is disconnected from the camera when switching the power source from 12 VDC to PoE.
- The network connector is not designed to be connected directly with cable or wire intended for outdoor use.
- It is required that you coil twice around the end of the network cable in the camera side by using the core (28A2024-0A2 model of Laird Technologies brand) provided with the camera for EMI (electromagnetic interference) suppression.

WARNING: ROUTE POWER CORDS SO THAT THEY ARE NOT A TRIPPING HAZARD. MAKE CERTAIN THE POWER CORD WILL NOT BE PINCHED OR ABRADED BY FURNITURE. DO NOT INSTALL POWER CORDS UNDER RUGS OR CARPET. USE THE POWER CORD THAT HAS A GROUNDING PIN. IF YOUR POWER OUTLET DOES NOT HAVE A GROUNDING PIN RECEPTACLE, DO NOT MODIFY THE PLUG. DO NOT OVERLOAD THE CIRCUIT BY PLUGGING TOO MANY DEVICES INTO ONE CIRCUIT.

Mounting

< Vandal Dome Model >

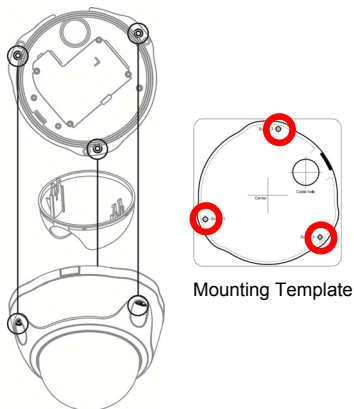

< Plastic Dome Model >

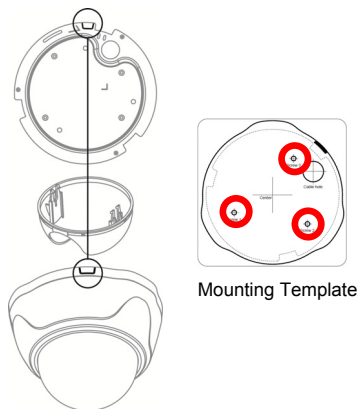

1. Screw the bottom cover to the wall or ceiling by using the mounting screws provided with the camera. Use the mounting template provided with the camera.
2. Connect the external devices, network and power adapter. If the camera is IP-66 level supported model, block the cable access hole for waterproofing by using the enclosed cable access hole rubber when routing wires and cables. Ask your dealer or distributor for details.
3. Adjust the angle of the lens for the proper view angle. Refer to the **View Angle** section below for details.
4. Adjust the focus and zoom by using the focus and zoom lever.
5. Fix the shield case in the tilt adjustment screw (IR LED non-supported model only).
6. If the camera is a vandal dome model, screw the dome cover to the bottom cover by using the setscrew provided with the camera. If the camera is a plastic dome model, match the mark beside the cable access hole of the bottom cover and the side cable access hole of the dome cover, and then turn the dome cover clockwise to lock the dome cover to the bottom cover.
7. Apply power.

WARNING: You might need to reinforce the wall or ceiling. If the wall or ceiling is not strong enough to support the camera, the camera might fall damaging the camera or causing injuries.

NOTE: Attach the enclosed desiccant beside the safety wire setscrew inside the dome cover to prevent moisture (IP66-level supported models only):

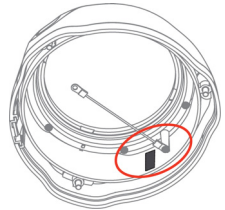

View Angle

Three-axis lens positioning is supported.

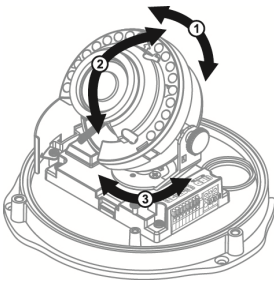

- ① **Rotation:** Adjusts the rotation angle. Move the rotation base clockwise or counterclockwise.
- ② **Tilt:** Adjusts the tilt angle. Loosen the tilt adjustment screws, move the lens up and down and tighten the screws to lock the angle.
- ③ **Pan:** Adjusts the pan angle. Turn the pan base clockwise or counterclockwise.

Chapter 3 — Remote Setup

Remote Setup allows you to change all settings of a camera. Run the INIT program, select a camera and click the Setup icon  on the Main screen. Select **Remote Setup** from the Setup menu and the **Remote Setup** screen appears. You can also display the **Remote Setup** screen by selecting a camera, clicking the right mouse button and selecting **Remote Setup** on the Main screen.

NOTE: You can also change the settings by using remote programs.

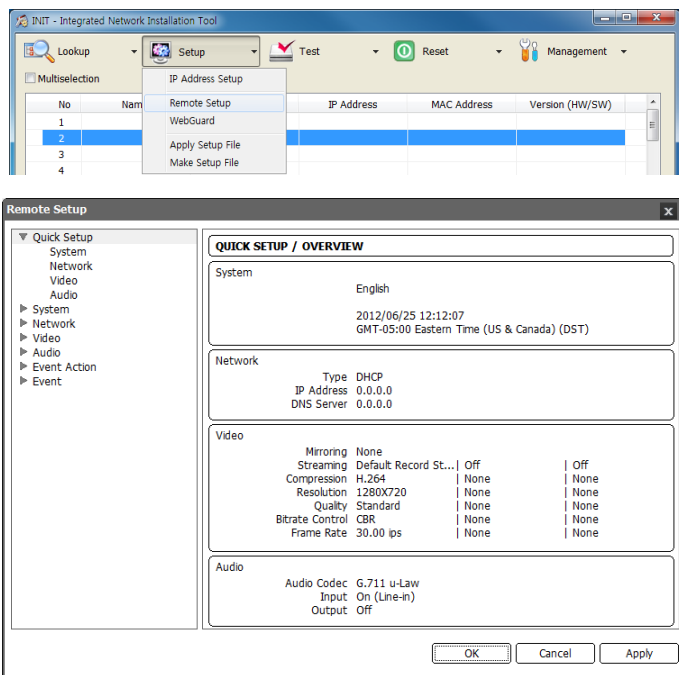

Clicking a menu on the left side of the Remote Setup screen displays the current settings for that menu on the right side of the screen. Clicking a submenu under each menu allows you to change the settings. Clicking the OK button closes the Remote Setup screen and applies the changes.

Quick Setup

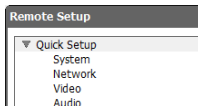

The Quick Setup allows you to change a camera's basic system, network, video and audio settings.

System

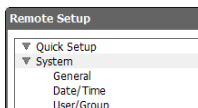

You can change a camera's system information, import or export all settings, and add users or groups.

General

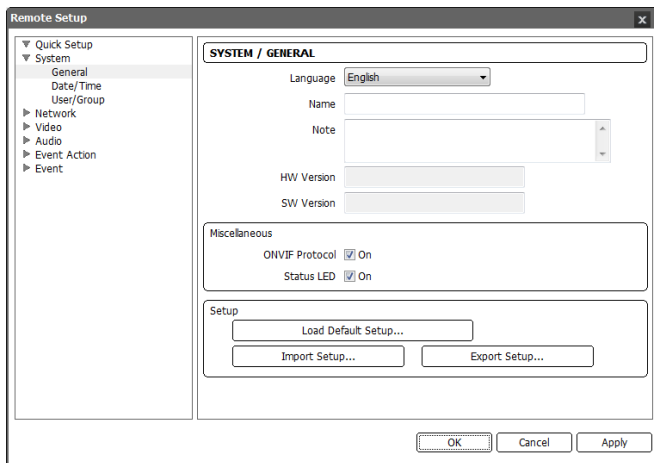

- **Language:** Choose the language to be used during remote setup.
- **Name:** Enter the camera name (up to 31 characters including spaces).
- **Note:** Enter additional information about the camera.
- **HW Version, SW Version:** These fields display the camera's hardware and software versions.
- **Miscellaneous:**
 - **ONVIF Protocol:** Check the box to enable the ONVIF protocol. The ONVIF protocol is available only for users belonging to the default user groups (Administrator, Operator, User).

- **Status LED:** Check the box to enable LEDs. If LEDs are not enabled, the LEDs on the product panel will not light regardless of the status.
- **Setup:**
 - **Load Default Setup...**: Click to return all settings except date/time to the original factory settings. You can select whether or not network settings will be included when the setup is applied. Refer to the **Network** setup for details of the network settings.
 - **Import Setup...**: Click to apply the settings saved as a .dat file format to the camera. A setup screen appears allowing you to select the setup file. You can select whether or not to include network settings (except DVRNS setting) when the setup is applied. Refer to the **Network** setup for details of the network settings.
 - **Export Setup...**: Click to save the current camera settings as a .dat file format. A setup screen appears allowing you to name the setup file.

NOTES:

- The *Load Default Setup* and *Import Setup* functions are permitted only to the users in the *Administrator* group.
- Do NOT check the *Include Network Setup* box when the network settings of the setup file are used in another camera. Otherwise, the connection to the camera might not be made properly.
- If the IP address, admin port number or SSL settings are changed during *Setup*, Remote Setup closes after saving the changes.

Date/Time

The screenshot shows the 'Remote Setup' dialog box with the 'SYSTEM / DATE/TIME' tab selected. On the left is a navigation tree with 'Date/Time' highlighted. The main area is divided into two sections:

- Date/Time:** Contains three rows of settings:
 - Date: 2012/06/25 (with a calendar icon) and a 'Format' dropdown.
 - Time: 12:12:12 (with a clock icon) and a 'Format' dropdown.
 - Time Zone: GMT-05:00 Eastern Time (US & Canada) (with a dropdown arrow).
 Below these is a checked checkbox for 'Use Daylight Saving Time' and an 'Apply' button.
- Time Sync:** Contains:
 - An unchecked checkbox for 'Automatic Sync'.
 - A 'Time Server' text input field.
 - An unchecked checkbox for 'Use DVRNS'.
 - An 'Interval' dropdown menu set to '1 hr.'.
 - An unchecked checkbox for 'Run as Server'.

At the bottom of the dialog are 'OK', 'Cancel', and 'Apply' buttons.

- **Date/Time:** Change the system date/time, date/time format and time zone. Turn daylight-saving time on or off by checking the box. Clicking the **Apply** button applies the changes immediately.

- Time Sync
 - Automatic Sync: Check the box to automatically synchronize the time with a time server. Enter the IP address or the domain name of the time server and set the time interval for synchronization. If the time server uses the DVRNS function, selecting the Use DVRNS box allows you to enter the name instead of the IP address or the domain name of the time server.
 - Run as Server: Check the box to run the camera as a time server.

NOTE: If you want to use a domain name instead of the IP address of the time server, the DNS server must be set up properly when setting *Network – IP Address* setup. If you want to use a name instead of the IP address or the domain name of the time server, the DVRNS function must be set up properly when setting the *Network – DVRNS* setup.

User/Group

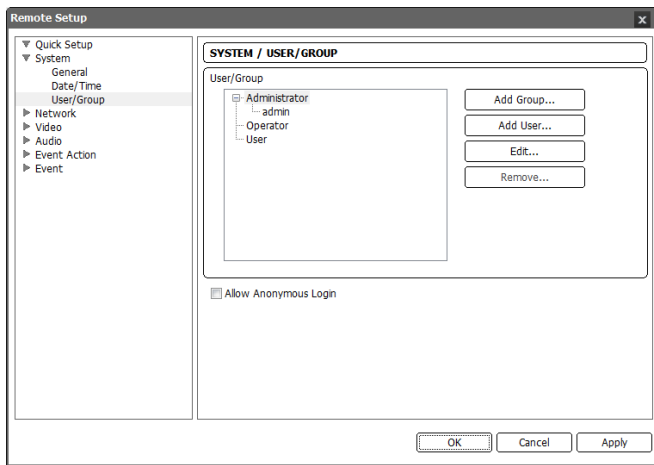

- User/Group: Click the buttons to change the settings for a group or a user allowed controlling the camera remotely.
 - Add Group: Click to add a group. Enter the group name and set authority levels for the group to control the camera remotely.
 - Add User: Click to add a user. Enter the user name and select the group that the user will belong to. Enter the password to be assigned to the user.
 - Edit: Select a group and click the button to change authority levels assigned to the group, or select a user and click the button to change the user's password.
 - Remove: Select a group or user and click the button to delete the group or user.
- Allow Anonymous Login: Check the box to use the webcasting feature. Refer to the Video – Webcasting setup for details.

NOTES:

- Only users belonging to the *Administrator* group can make *User/Group* changes.
- There is no default password for the *admin* user in the *Administrator* group.
- The default groups (*Administrator*, *Operator*, *User*) cannot be edited or deleted. The same authority levels are assigned to the user groups in the ONVIF protocol.
- The authority levels that can be assigned are:
 - *Upgrade*: The user can upgrade the software.
 - *Setup*: The user can set up the system.
 - *Color Control*: The user can control brightness, contrast, hue and saturation for cameras.
 - *Alarm-Out Control*: The user can reset the output during an alarm.
 - *System Check*: The user can view and check the remote system status.
 - *Search*: The user can search video recorded on the SD memory card by using a remote program.
 - *Clip Copy*: The user can export video recorded on the SD memory card as a video file by using a remote program.

Network

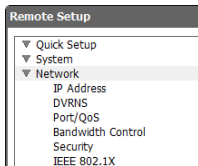

You can change the network settings, set up the DVRNS and security functions and control the network bandwidth.

IP Address

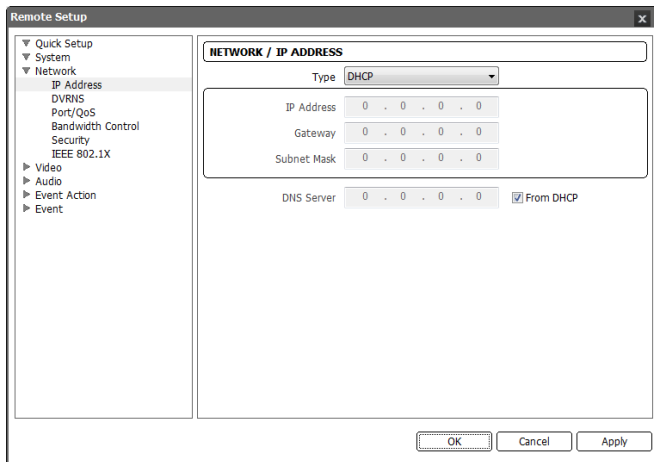

- **Type:** Select the type of network configuration. Remote Setup closes after saving the changes.
 - **Manual:** Select when the camera is using a static IP address for network connection, and set up LAN parameters manually.
 - **DHCP:** Select when the camera is networked via DHCP (Dynamic Host Configuration Protocol). Click the OK button, and a temporary IP address is automatically assigned to the camera. The camera periodically will be issued a new IP address automatically.
 - **ADSL:** Select when the camera is networked via ADSL. Enter the ID and password for ADSL connection, and click the OK button. A temporary IP address is automatically assigned to the camera. The camera periodically will be issued a new IP address automatically.
- **DNS Server:** Enter the IP address of the DNS server. If you set up the DNS server, the domain name of the server can be used instead of the IP address during the DVRNS, time or SMTP server setup. Ask your Internet service provider for the IP Address of the DNS Server. When the camera is networked via DHCP, selecting From DHCP automatically assigns the IP address of the DNS server. The assigned IP address is displayed the next time it is connected.

NOTES:

- Ask your network provider for details about the network connection type and connection information for the camera or the IP address of the DNS server.
- If the camera is configured for a DHCP or ADSL network, it is best to use the DVRNS function because the camera IP address might change frequently.

DVRNS

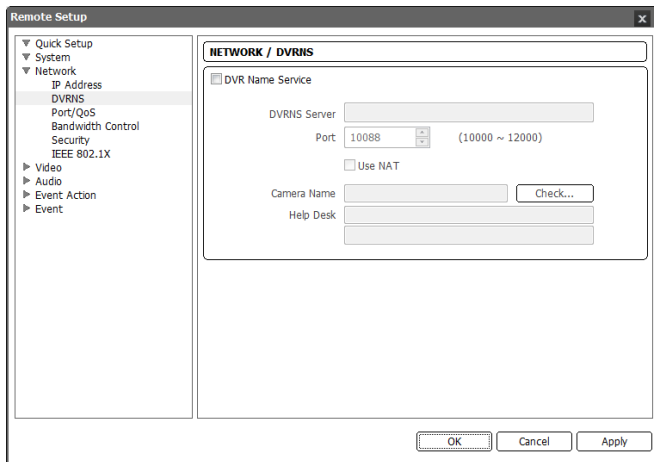

Check the **DVR Name Service** box to use the DVRNS function.

- **DVRNS Server:** Enter the IP address or domain name of the DVRNS server.
- **Port:** Set up the port number of the DVRNS server.
- **Use NAT:** Check the box when the camera uses a NAT (Network Address Translation) device for network connection.
- **Camera Name:** Enter the camera name to be registered on the DVRNS server. Check whether or not the name is available by clicking the **Check** button.
- **Help Desk:** Choosing the **OK** button registers the camera on the DVRNS server. Proper DVRNS settings will display the help desk information of the DVRNS server.

NOTES:

- The DVRNS (DVR Name Service) function allows the camera to use dynamic IP addresses for remote connection. When using this function, you can access the camera remotely by using the camera name instead of its IP address. For the DVRNS function to work properly, the camera should be registered on the DVRNS server, and the DVRNS server settings in the INIT program for the camera should match the settings registered on the DVRNS server. Any changes on the DVRNS server might cause improper operation.
- When LAN settings are changed, set up the DVRNS settings after saving your LAN changes by clicking the **OK** button.
- You will need to get the IP address or domain name of the DVRNS server from your network administrator. You can use the domain name instead of IP address if you set up the DNS server during the IP Address setup.

NOTES:

- When using a NAT (Network Address Translation) device, refer to the NAT manufacturer's instructions for the proper network settings.
- The camera name you entered in the *Camera Name* field should be checked by clicking the *Check* button, otherwise the DVRNS changes will not be saved. When entering no name or a name already registered on the DVRNS server, an error message displays. If a camera name includes the #, \, or % characters, connections to the camera using a WebGuard program might fail.

Port/QoS

The screenshot shows the 'Remote Setup' window with the 'NETWORK / PORT/QOS' configuration page. The left sidebar has a tree view with 'Port/QoS' selected. The main area contains a table for configuring ports and DSCP values, and checkboxes for 'Use HTTPS' and 'Use UPnP'.

	Use	Port	DSCP
Admin	<input checked="" type="checkbox"/>	8200	0
Watch	<input checked="" type="checkbox"/>	8016	0
Record	<input checked="" type="checkbox"/>	8017	0
Search	<input checked="" type="checkbox"/>	10019	0
WebGuard	<input checked="" type="checkbox"/>	80	0
RTSP	<input checked="" type="checkbox"/>	554	0

Below the table, there are two checkboxes: Use HTTPS and Use UPnP. A 'Check...' button is located to the right of the checkboxes.

At the bottom of the window, there are three buttons: 'OK', 'Cancel', and 'Apply'.

- **Use, Port:** Check the box to enable and enter the port number. **Admin, Watch, Record** and **Search** ports are set to use by default and you cannot change it. Checking the **WebGuard** or **RTSP** box allows you to connect to the camera by using the WebGuard program or media players, such as VLC Player, supporting RTSP (Real-Time Streaming Protocol) service. Remote Setup closes after saving the changes (Admin port number only).
- **DSCP:** Enter the DSCP value to set up the QoS (Quality of Service) level for each port. It decides order of priority to use network bandwidth for each port. The higher the DSCP value, the higher the QoS level and order of priority when allocating network bandwidth. When the DSCP value is set to 0, the QoS level is not set up. For this function to work properly, the network environment should support DSCP. Ask your network administrator for details.
- **Use HTTPS:** Check the box to enhance the security of WebGuard pages by using the HTTPS protocol when running the WebGuard program.

- **Use UPnP:** Check the box to connect to the camera without manually setting up port forwarding on the NAT device when the camera uses a NAT (Network Address Translation) device for network connection. The UPnP function must also be enabled in the NAT device for this function to work. Refer to the NAT device User's Manual for details on enabling the UPnP function in the NAT device. Clicking the **Check** button checks the current port settings. A success message is displayed if all the current port numbers are available, and recommended port numbers are displayed if any of the current port numbers are not available.

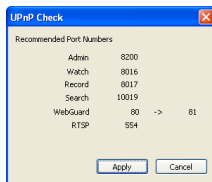

Clicking the **Apply** button applies the recommended port numbers.

NOTES:

- Do NOT use the same port number for more than one function. If you do, the camera cannot be connected with the remote programs.
- You can access the camera and monitor live video images using media players, such as VLC Player, supporting RTSP service. You should open all ports for UDP protocol or an RTSP port for TCP protocol if the camera uses a NAT (Network Address Translation) device for network connection or if the firewall is enabled. This function might not be supported, depending on the type of media player, and some media players might not play video properly depending on network conditions or compression or resolution of images for streaming. You can access video as follows:
 - Access from a PC: Start the media player and enter "*rtsp://user:Password@IP address:RTSP port number/trackID=stream number*" (the number for the primary stream is 1, for the secondary stream is 2, and for the tertiary stream is 3)
(e.g. *rtsp://admin:@10.0.152.35:554/trackID=1* (user: *admin*, password: no password, camera IP address: *10.0.152.35*, RTSP port number: *554*, stream: primary))
 - Access from mobile devices: Start web browser on the mobile device and enter "*http://IP address:WebGuard port number/*" (*https* instead of *http* if the *Use HTTPS* box is checked). For this connection to work, the WebGuard and RTSP port numbers must be set up properly.

CAUTIONS:

- **When changing the port settings, you must change the port settings on remote programs too.**
- **When using the HTTPS protocol, the ONVIF protocol might not work.**

Bandwidth Control

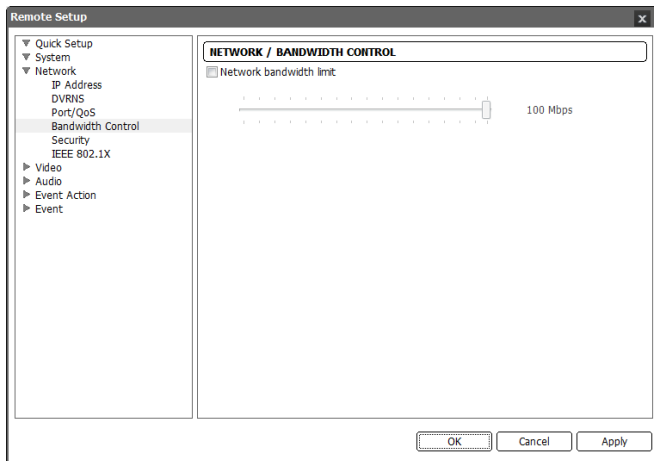

You can control the network bandwidth by limiting the network bandwidth of the camera depending on the network traffic.

Check the **Network bandwidth limit** box and set the desired maximum bandwidth. When the network is busy with traffic, the camera cannot use more than the maximum bandwidth.

NOTE: When limiting the network bandwidth, the frame rate might decrease to lower than the frame rate set during the *Video – Streaming* setup.

Security

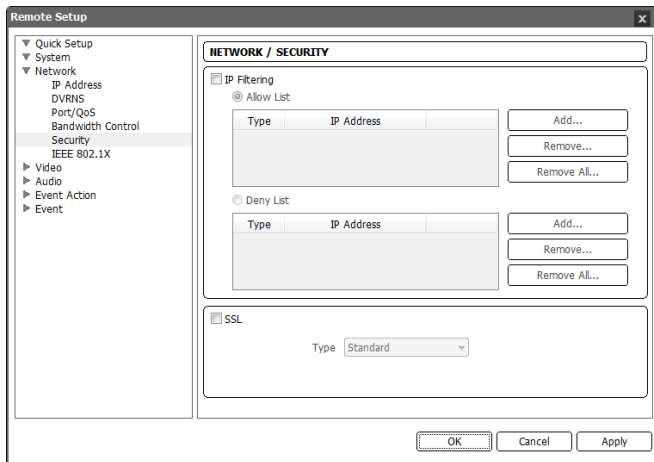

- **IP Filtering:** Check the box to use the IP filtering function. You can allow or block connections to the camera by designating IP addresses.
 - **Add:** Click the button to add IP addresses to the **Allow List** or **Deny List** to allow or block connection to the camera. Selecting the **Host** option allows you to add one IP address at a time. Selecting the **Group** option allows you to add continuous IP address numbers in one action by designating a range of IP addresses to add.
 - **Remove, Remove All:** Click the button to remove the selected IP address or all IP addresses from **Allow List** or **Deny List**.
- **SSL:** Check the box to use the SSL function. You can enhance the security of outgoing data from the camera by using the SSL (Secure Sockets Layer) protocol. When using the SSL function, the camera cannot be connected with a program or a system that does not support the SSL function. Remote Setup closes after saving the changes.

NOTES:

- If you want to use the time synchronization, DVRNS and Email sending functions, the connection of the IP addresses of the time server, DVRNS server and the SMTP server must be allowed when you set up the IP filtering function. Any connection to the camera from the IP address in *Deny List* will NOT be allowed.
- Using the SSL function might cause congestion in the system receiving data from the camera depending on the security level.
- This product includes software developed by the OpenSSL Project for use in the OpenSSL Toolkit (<http://www.openssl.org/>)

IEEE 802.1X

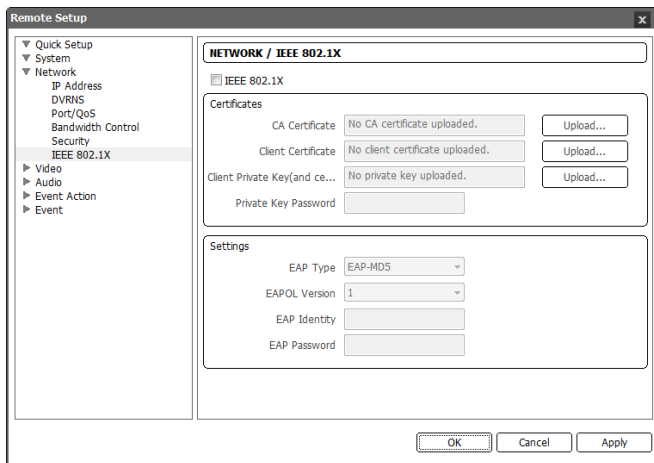

Check the IEEE 802.1X box to use the IEEE 802.1X network connection authentication function.

- **Certificates:** Uploads a certificate or private key for network connection depending on the authentication type. Entering a private key password might be required depending on the authentication type.
- **Settings:** Sets up EAP (Extensible Authentication Protocol).
 - **EAP Type:** Select the type of authentication to be used for network connection authentication. The authentication type must be identical to the authentication type that the authentication server uses.
 - **EAPOL Version:** Select the EAP version.
 - **EAP Identity, EAP Password:** Enter the ID and password for the authentication.

NOTE: For the IEEE 802.1X network connection authentication function to work properly, the authentication server and AP should support the IEEE 802.1X authentication.

Video

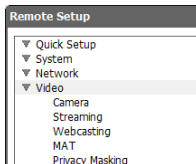

You can set up camera setting and features for streaming, webcasting, MAT and privacy masking.

Camera

Image Sensor: Click the tab to set up image sensor settings.

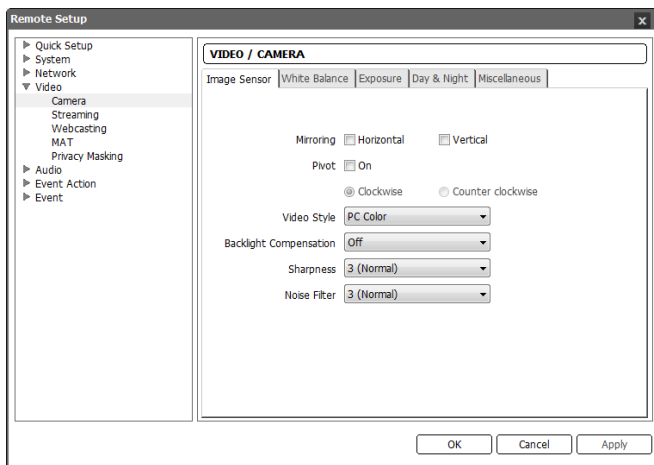

- **Mirroring:** Check the Horizontal or Vertical box to flip images horizontally or vertically.
- **Pivot:** Set whether to enable or disable the pivot function. When the pivot function is enabled, images are rotated 90 degrees clockwise or counterclockwise. If vertical resolution is less than 320, this function is not supported. If you enable this function, you can monitor more efficiently long and narrow space such as hallways, corridors, etc.
- **Video Style:** Select the video style between TV Color and PC Color.
- **Backlight Compensation:** Set whether to enable or disable the backlight compensation.
 - OFF: Disables the BLC function.
 - ON: When images are very bright overall due to backlight, subjects in front of bright backgrounds will be clearer under backlight circumstances.

- **HSBLC (High Suppress Backlight Compensation):** When a certain area of images is very bright in the screen due to backlight under low lighting conditions and it causes the other area to be very dark, this function provides the other area of images brightly and clearly by blocking the backlight in the certain area. For example, when car headlights block a license plate at night, this function allows you to recognize the license plate by blocking the headlight.
- **Sharpness:** Set the sharpness of images. The camera adjusts the edges in images to enhance the sharpness of images. The higher the value is, the sharper the images appear but it might cause increased image noise when the value is too high.
- **Noise Filter:** Set the degree of the noise filtration. This adjustment can be used to decrease noise in low light conditions. The higher the value is set, the less the noise there is. However, too high of a setting might cause overall image blurring.

White Balance: Click the tab to set up white balance settings.

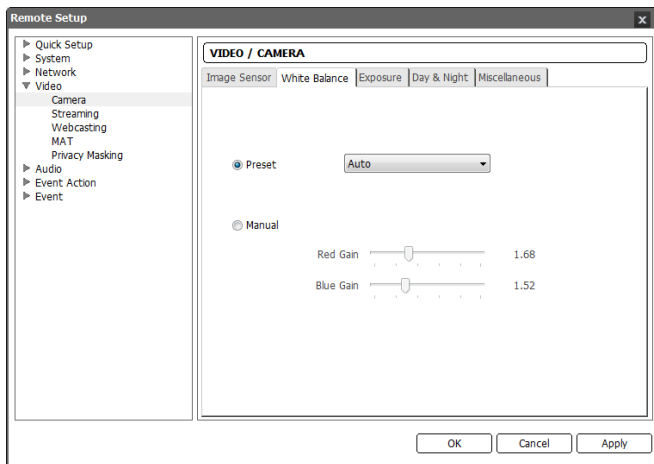

- **Preset:** Select the preset white balance value based on the conditions.
 - **Auto:** Select to adjust the white balance automatically. The system identifies the light source of where the camera is installed and sets up the proper white balance for the conditions.
 - **INCANDESCENT ~ Fluorescent Cold:** Select the type of light source of where the camera is installed to set the proper white balance for the conditions.
- **Manual:** Select to adjust the white balance manually. Adjust the Red and Blue gain. The higher the value, the stronger the color is.

Exposure: Click the tab to set up exposure settings.

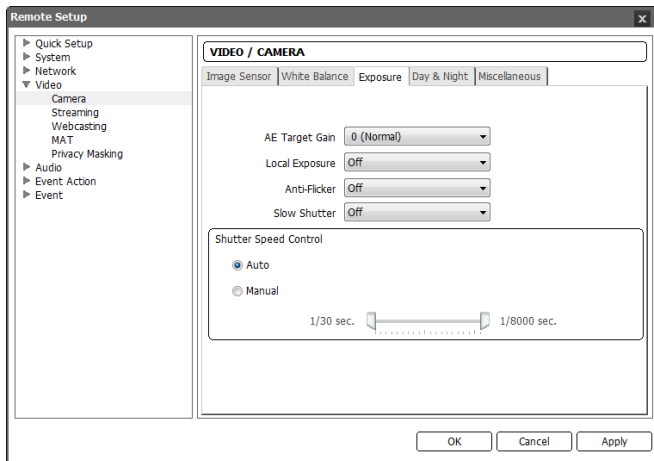

- **AE Target Gain:** Set the target gain for the exposure compensation. The camera compensates the exposure automatically based on the selected target gain. The higher the value is, the brighter the images are.
- **Local Exposure:** Set the local exposure. It provides images except the backlight area clearly when very dark and very bright areas exist simultaneously in the screen for backlight under low light conditions. For example, when car headlights block a license plate at night, you can recognize the license plate by blocking the headlight. The higher the value is, the clearer images are.
- **Anti-Flicker:** Set to the same frequency as the lighting when the AC power is used for the lighting such as a fluorescent lights. This reduces video flicker caused by the frequency differences (60 Hz for NTSC, 50 Hz for PAL).
- **Slow Shutter:** Set the slow shutter mode. Selecting a speed automatically decreases the electronic shutter speed during low light conditions so that images are displayed bright even though the lighting is dim.
- **Shutter Speed Control:** Set the shutter speed. This is enabled only when both the Anti-Flicker and Slow Shutter settings are set to Off.
 - **Auto:** Select to adjust the shutter speed automatically. The system identifies the light conditions of where the camera is installed and sets the proper speed for the conditions.
 - **Manual:** Select to adjust the shutter speed manually. Adjust the lowest and highest speed by using slider bars based on the light conditions of where the camera is installed.

NOTE: Selecting *Auto* for some functions sets up the functions automatically based on the conditions.

Day & Night: Click the tab to set up day & night settings.

IR LED Supported Model

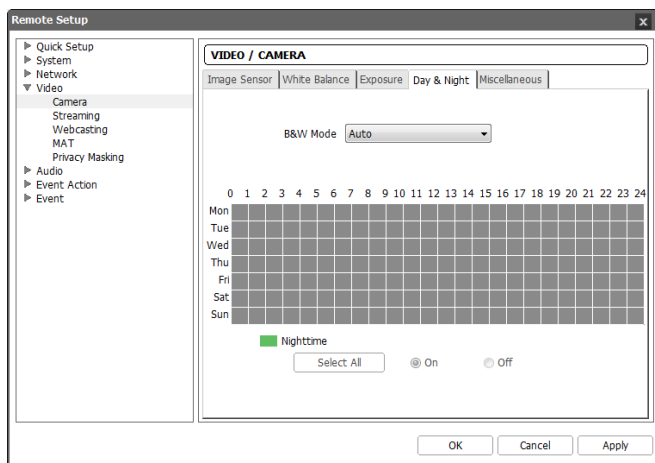

IR LED Non-Supported Model

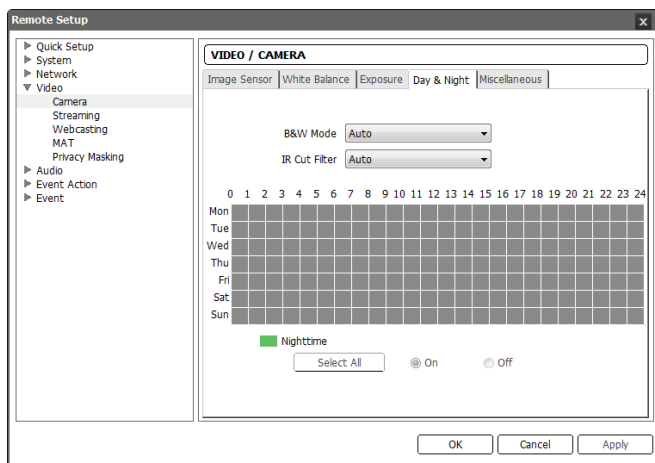

- **B&W Mode:** When in the black and white mode, images are displayed in black and white and are clearer in low light conditions. This feature will be disabled if the **Day & Night Mode** event action is enabled during the **Event – Alarm In** setup.
 - **Off, On:** Disables or enables the black and white mode.
 - **Auto:** Disables or enables the black and white mode automatically based on the conditions where the camera is installed.
 - **Schedule:** Sets up the black and white mode schedule. The black and white mode is enabled during the date and time scheduled as **Nighttime** and disabled during the rest. Set up or release **Nighttime** by selecting **On** or **Off** in the bottom and clicking or dragging the date and time area in the table. Selecting **On** or **Off** and clicking the **Select All/Clear All** button sets up or releases **Nighttime** for all dates and time.
- **IR Cut Filter:** When the IR cut filter is enabled, the camera blocks infrared light (IR LED non-supported model only). Images can be displayed clearly in various lighting conditions by blocking infrared light in bright light conditions and allowing infrared light in low light conditions. This feature will be disabled if the **Day & Night Mode** event action is enabled during the **Event – Alarm In** setup.
 - **Daytime Mode, Nighttime Mode:** Disables or enables the IR cut filter.
 - **Auto:** Disables or enables the IR cut filter automatically based on the conditions where the camera is installed.
 - **Schedule:** Sets up the IR cut filter schedule. The IR cut filter is disabled during the date and time scheduled as **Nighttime** and enabled during the rest. Set up or release **Nighttime** by selecting **On** or **Off** in the bottom and clicking or dragging the date and time area in the table. Selecting **On** or **Off** and clicking the **Select All/Clear All** button sets up or releases **Nighttime** for all dates and time.

Miscellaneous: Click the tab to set up other settings.

IR LED Supported Model

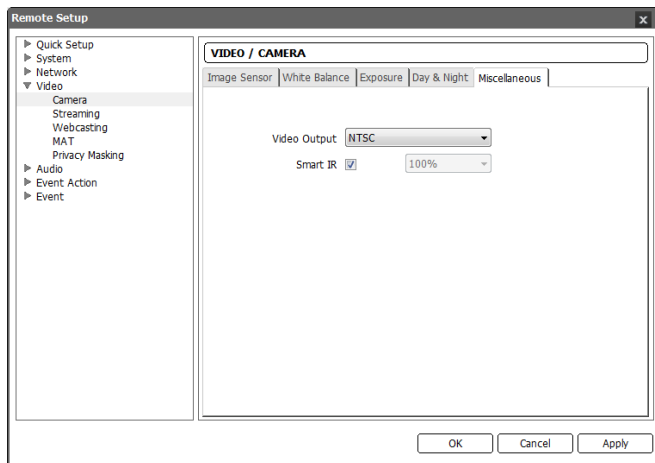

IR LED Non-Supported Model

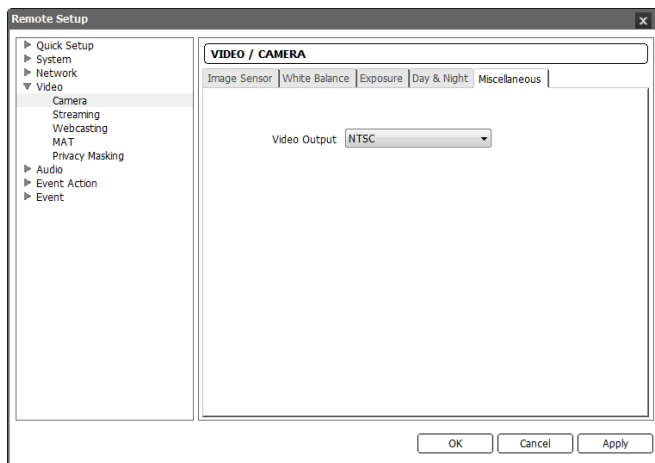

- **Video Output:** Select the video signal for video output.

- **Smart IR:** Set the brightness of the IR LED (IR LED supported model only). Check the box to adjust the brightness automatically. The sensor in the middle of IR LEDs detects illumination. Uncheck the box to set the brightness manually. The higher the value is set, the brighter it is.

Streaming

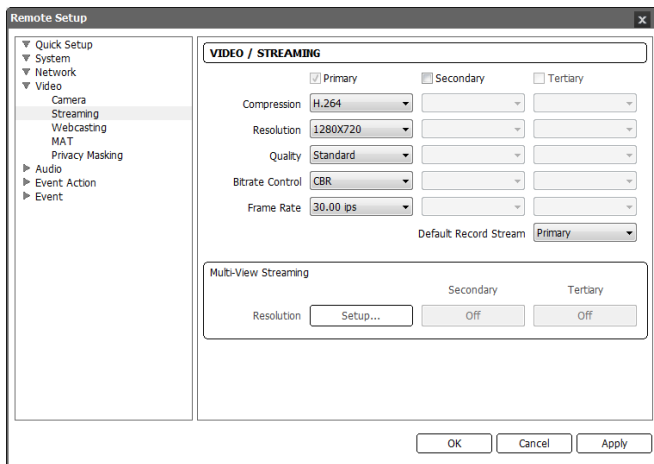

- **Primary, Secondary, Tertiary:** The camera supports multistream video (priority: Primary > Secondary > Tertiary). Set whether to enable or disable the streams. Some of the settings may change depending on the settings of streams of higher priority and the tertiary stream may not be available (see the table below).

Model	Primary		Secondary		Tertiary	
	Resolution	ips	Resolution	ips	Resolution	ips
HD	1280x720	30	1280x720	15	–	–
Full HD	1920x1080	30	704x480	30	–	–

- **Compression:** Set up the compression of images for streaming.
- **Resolution:** Set the resolution of images for streaming. The resolution varies depending on the camera model. The resolution of the current stream cannot exceed that of a stream of higher priority.
- **Quality:** Set up the quality of images for streaming.
- **Bitrate Control:** Set up the bitrate control mode for H.264 compression.
 - CBR (Constant Bitrate): Maintains the current bitrate regardless of the amount of motion.
 - VBR (Variable Bitrate): Adjusts the bitrate dynamically based on the amount of motion. The less motion there is, the less network congestion and the less storage consumption. The quality may not be as good when compared to the CBR mode.

- **Frame Rate:** Set the frame rate of images for streaming. The frame rate of the current stream cannot exceed that of a stream of higher priority if the resolution of the current stream is the same as that of the stream of higher priority.
- **Default Record Stream:** Select a stream to use for recording. If a recording stream is set up in a remote program or recording on an SD memory card is enabled in this camera, this setting may not be applied. Refer to the **Event Action – Record, Preference** setup for details.
- **Multi-View Streaming:** It allows you to set up a streaming area to stream specific area of video (not supported for the primary stream). Click the **Setup** button and set up the streaming area.

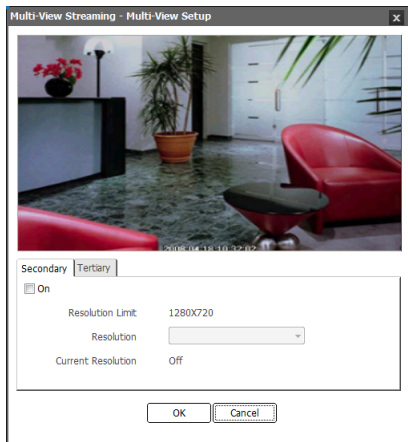

Checking the **On** box allows you to set up the streaming area.

- **Resolution Limit:** Displays the available maximum resolution of the streaming area.
- **Resolution:** Sets the streaming area. The streaming area is displayed in red on the screen above and you can adjust the area resolution or moves the area location by using the mouse drag and drop.
- **Current Resolution:** Displays the current resolution of the streaming area.

NOTE: Simultaneous connections to the camera might cause the frame rate to decrease due to the network bandwidth overload.

Webcasting

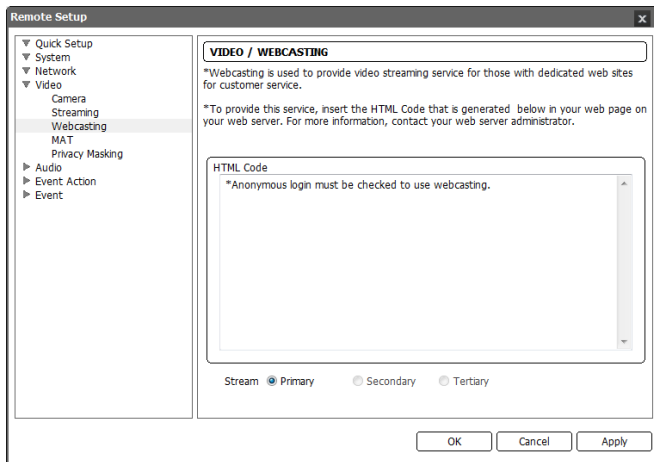

The camera can stream live video from the camera to a website.

- **HTML Code:** Copy the HTML Code that is displayed on the screen and paste it in your web page code.
- **Stream:** Select a stream to use for webcasting. Only the streams in use are available.

NOTE: To use the webcasting service, you must check the *Allow Anonymous Login* option during *3.2 System – User/Group* setup.

MAT

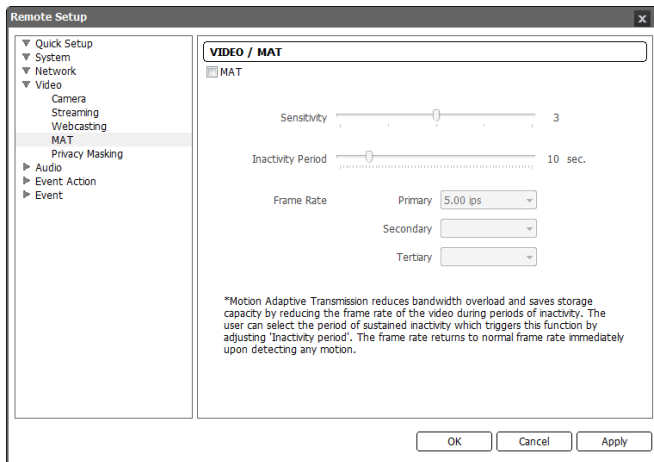

Check the MAT box to use the MAT (Motion Adaptive Transmission) function for video streaming and recording.

- **Sensitivity:** Set the motion sensitivity. The higher the number is, the more sensitive it is.
- **Inactivity Period:** Set the inactivity period. The camera will transmit or record images in **Frame Rate** set below until any change is detected after the inactivity period when no motion is detected during the preset inactivity period.
- **Frame Rate:** Select the frame rate to be applied when no motion is detected. This frame rate may change when the slow shutter mode is enabled in the **Video – Camera** menu. The selected frame rate will be applied until any motion is detected after the inactivity period and will return to the normal frame rate set during the **Stream** setup immediately upon detecting any motion.

NOTE: The MAT (Motion Adaptive Transmission) function allows you to reduce bandwidth overload and to save storage capacity by reducing the frame rate when no motion is detected. The camera considers that no motion is detected when no change is detected between two consecutive images based on the sensitivity setting.

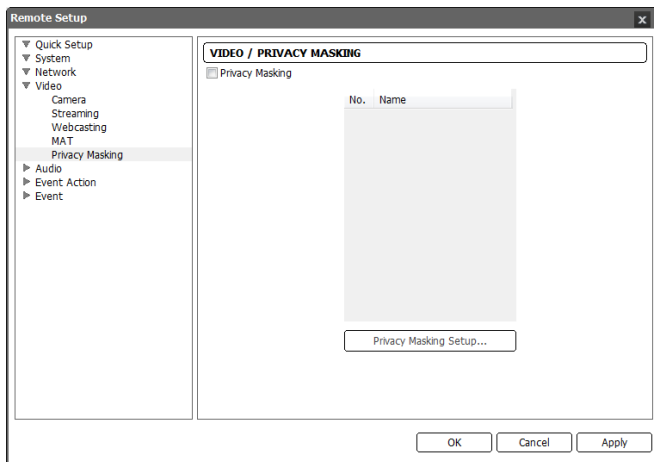

Privacy Masking

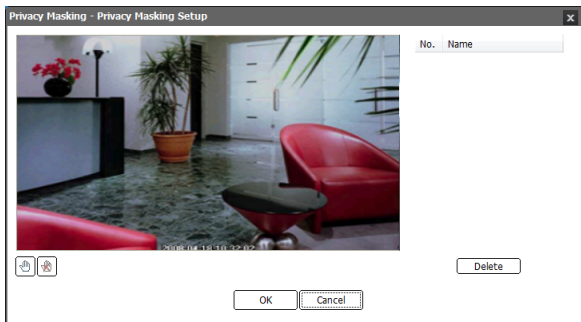

Check the **Privacy Masking** box to restrict monitoring of specific areas for privacy reasons. The privacy masking areas are displayed in the black color during monitoring.

- **Privacy Masking Setup:** Set up privacy masking areas (max. 16).



-  (Select) or  (Clear): Click to select or clear a block for privacy masking area. You can select or clear the several blocks of an area using the mouse dragging.
- **No. / Name:** Displays a list of the preset privacy masking areas. The number indicates the number displayed in the privacy masking area. Clicking the empty space beside the number in the list allows you set up a name for the area. Clicking the **Delete** button deletes the area.

Audio

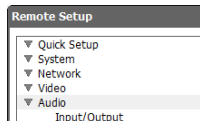

You can set up audio in and out.

Input/Output

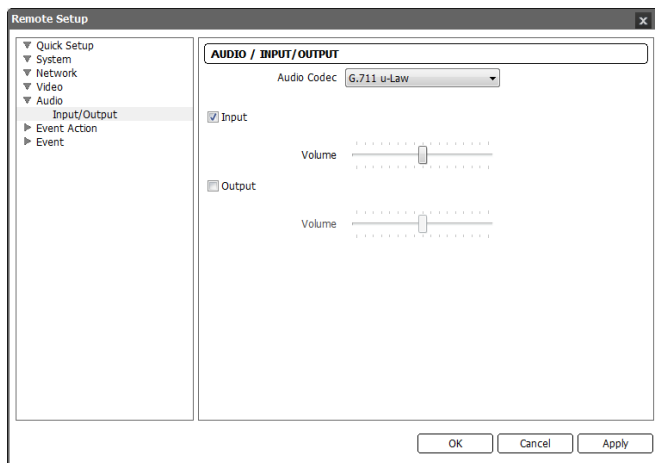

- **Audio CODEC:** Select an audio codec.
- **Input:** Check the box to enable audio in and adjust the volume.
- **Output:** Check the box to enable audio out and adjust the volume.

NOTE: The camera does not have amplified audio output, so you need to use a speaker with an amplifier.

Event Action

You can set up event actions to be taken when the camera detects events.

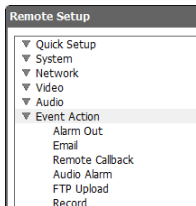

Alarm Out

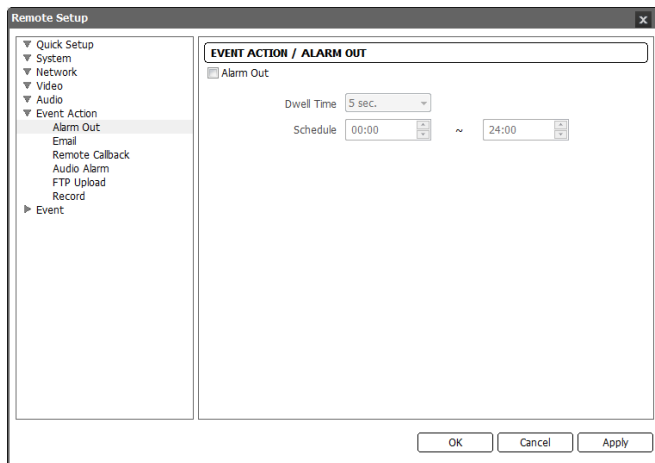

Check the Alarm Out box to activate alarm out.

- **Dwell Time:** Select the alarm-out dwell time. An alarm out is activated for the preset dwell time after detecting an event.
- **Schedule:** Set up the period to enable alarm out. An alarm out can be activated only during this period.

Email

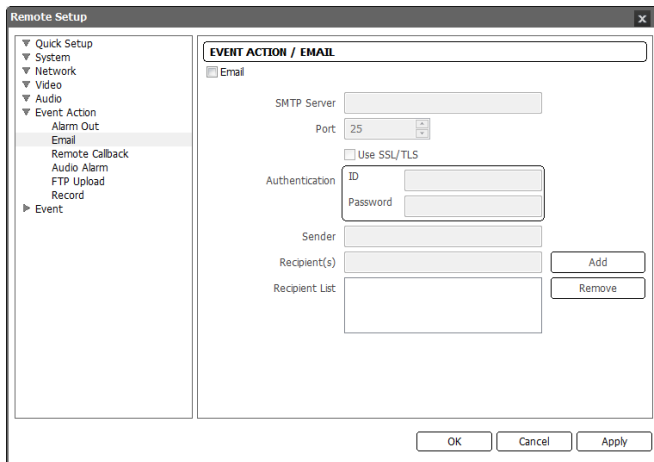

Check the Email box to send an email.

- **SMTP Server, Port:** Enter the IP address or domain name and port number of the SMTP server attained from your network administrator. You can use the domain name instead of the IP address if you set up the DNS server when setting up the network. Select **Use SSL/TLS** if the SMTP server requires SSL (Secure Sockets Layer) authentication.
- **Authentication:** Enter the ID and password if the SMTP server requires user authentication.
- **Sender, Recipient:** Enter the sender's and recipients' (max. 10) email address. An email address must include the "@" character to be a valid address.

Remote Callback

Remote Setup

- Quick Setup
- System
- Network
- Video
- Audio
- Event Action
 - Alarm Out
 - Email
 - Remote Callback**
 - Audio Alarm
 - FTP Upload
 - Record
- Event

EVENT ACTION / REMOTE CALLBACK

Remote Callback

	IP Address	Port (8000~12000)
1	- . - .	8201
2	- . - .	8201
3	- . - .	8201
4	- . - .	8201
5	- . - .	8201

Retry: 5

OK Cancel Apply

Check the **Remote Callback** box to send a callback message to remote systems (Not supported for the WebGuard program).

- **IP Address, Port:** Enter the IP addresses and port numbers of the remote systems to send a message.
- **Retry:** Select the number of times to try sending a message if it fails to send.

Audio Alarm

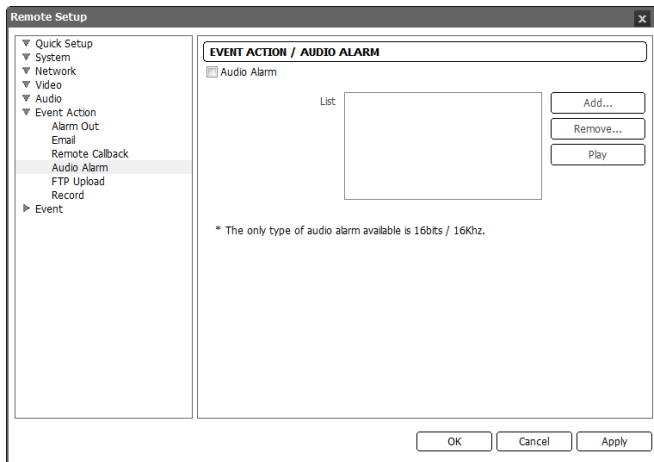

Check the Audio Alarm box to sound by playing back an audio file.

- **List:** Displays the audio file to be played back. You can add or delete an audio file (.wav) (16 bits/16 KHz encoded file only) by clicking the **Add** or **Remove** button. Selecting an audio file in the list and clicking the **Play** or **Stop** button allows you to test the sound by playing back the selected audio file.

FTP Upload

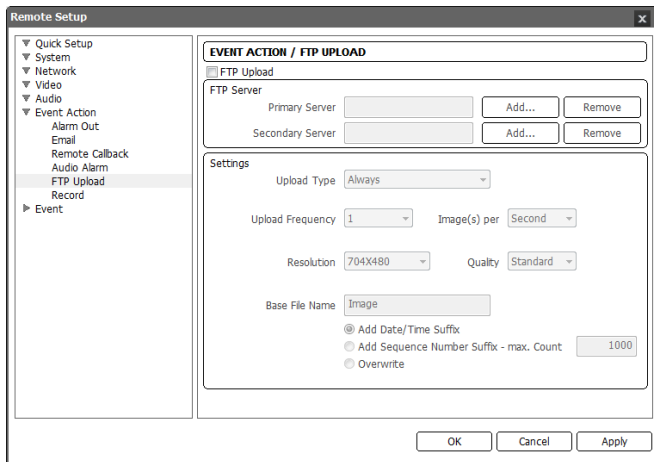

Check the FTP Upload box to upload event detected images in JPEG file format to an ftp server.

- **FTP Server:** Click the **Add** button to register an ftp server. Clicking the **Remove** button deletes the registered ftp server. When an event is detected, the event detected images will be uploaded in JPEG file format to the ftp server registered as a primary server. If images fail to be uploaded to the primary server, they are uploaded to the secondary server until uploading to the secondary server fails.

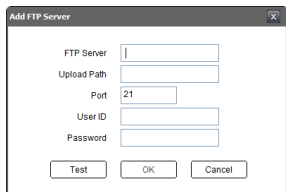

- **FTP Server:** Enter the IP address (or domain name) of the ftp server.
- **Upload Path:** Enter the folder path to upload files. Special characters (\ # * | : " < > ?) cannot be used in the folder path.
- **Port:** Enter the port number of the ftp server.
- **User ID, Password:** Enter the user ID and password for the connection to the ftp server.

Click the **Test** button to check the connection to the ftp server with the information set above. When the test succeeds, click the **OK** button.

- **Image:** Set up the image and upload settings for ftp upload.
 - **Upload Type:** Select the upload type. When the upload type is set to **Always**, images will be uploaded to the ftp server according to the settings below regardless of the event detection. When the upload type is set to **Event**, images will be uploaded to the ftp server according to the settings below when events are detected.

- **Upload Frequency:** Displays only when the upload type is set to **Always**. Set up the upload rate, and the preset number of images will be uploaded to the ftp server during the preset time.
- **Upload 1 image per:** Displays only when the upload type is set to **Event**. Set up the upload rate. Selecting **Upload for** allows you to set how long after an event is detected that event detected images will be uploaded and at what upload rate. Selecting **Upload while event status is active** uploads event detected images at the upload rate while an event is detected.
- **Resolution, Quality:** Select the resolution and quality of the images to be uploaded to the ftp server. The available resolution may change depending on the resolution setting in the **Video – Streaming** menu.
- **Base File Name:** Enter the common file name of the images to be uploaded to the ftp server and select the option to distinguish each image file. Special characters (\ / # * | : " < > ?) cannot be used in the file name. Selecting **Add Date/Time Suffix** adds the event detection date and time to each image file name. Selecting **Add Sequence Number Suffix – max. Count** adds the sequence number according to the event detection order to each image file name. Selecting **Overwrite** overwrites the previous image file. The event type is added to the image file name automatically.

NOTES:

- When the resolution of each stream set in the **Video – Streaming** menu is all different, the video resolution for FTP upload is fixed at the resolution of the tertiary stream (full HD model only).
- Consider the performance of the FTP server when setting up the upload rate during the **Upload Frequency** or **Upload 1 image per** setting. The FTP upload might fail if the upload rate exceeds the performance of the FTP server.

Record

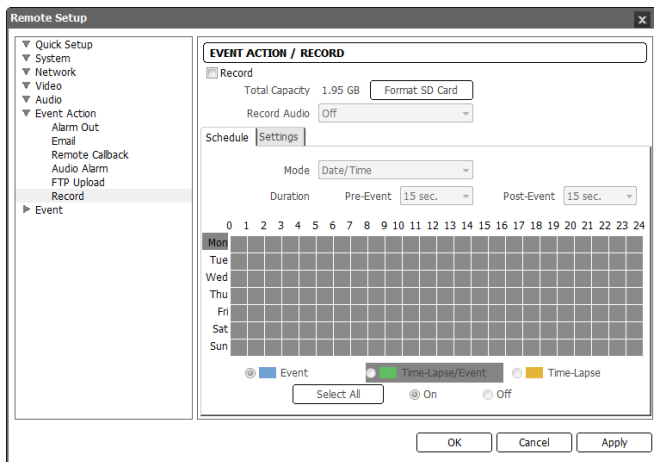

Check the **Record** box to enable recording on a micro SD memory card. Ensure that the SD memory card (Class 6 or higher) is inserted properly.

- **Total Capacity:** Displays the total capacity of the SD memory card when an SD memory card is inserted properly.
- **Format SD Card:** Click the button to format the inserted SD memory card. Formatting the SD memory card deletes all data saved on the SD memory card. Only users belonging to the Administrator group can format the SD memory card.
- **Record Audio:** Select whether or not to record audio.

Schedule: Click the tab to set up the recording schedule.

- **Mode:** Set up the recording mode.
 - **Always – Event:** Records video in the event recording mode. Video is recorded only when an event is detected.
 - **Always – Time-Lapse:** Records video in the time-lapse recording mode. Video is recorded continuously regardless of event detection.
 - **Always – Time-Lapse/Event:** Records video in the time-lapse recording mode while no event is detected and changes to the event recording mode when an event is detected.
 - **Date/Time:** Records video in the preset recording mode for each date and time setting. Select **On** or **Off** and then select the recording mode. Set up or release the recording mode by clicking or dragging the date and time area in the table. Selecting **On** or **Off** and clicking the **Select All/Clear All** button sets up or releases the recording mode for all dates and time.
- **Duration:** Select the time span to record video when in the event recording mode.
 - **Pre-Event:** Select the time span to record video before an event is detected. The camera can record a maximum of 60 MB of video. If the resolution, quality and frame rate for recording are set too high and recording capacity during the preset time exceeds 60 MB, not all video during the time will be recorded.
 - **Post-Event:** Select the time span to record video after an event is detected.

Settings: Click the tab to set up recording settings.

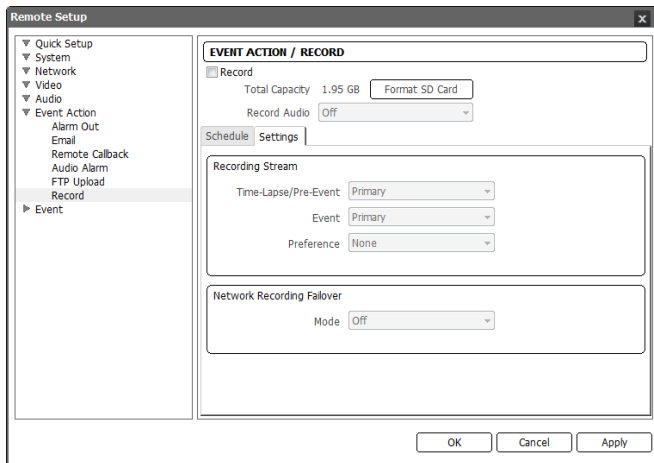

- **Recording Stream:** Select a stream to use for recording.
 - **Time-Lapse/Pre-Event, Event:** Allows using a different stream depending on the recording mode.
 - **Time-Lapse/Pre-Event:** Select the stream to use for recording when in the time-lapse recording mode or for pre-event recording when in the event recording mode.
 - **Event:** Select the stream to use for post-event recording when in the event recording mode.
- **Preference:** Sets up the priority of a stream to use for recording.
 - **SD Recording:** Records video by using the Time-Lapse/Pre-Event and Event streams set above.
 - **Network Recording:** Records video by using the recording stream set in a remote program. If a recording stream is not set up in a remote program, it uses the Default Record Stream set during the **Video – Streaming** setup.
 - **None:** Records video by using whichever stream offers higher resolution between the SD Recording stream and Network Recording stream.
- **Network Recording Failover – Mode:** Set up the network recording failover mode. It allows recording video on the SD memory card when recording using a remote program fails. It records video using the stream set during the **Recording Stream – Event** setup above. If the recording mode is set to **Always – Time-Lapse** in the **Schedule** tab, this will not be supported.
 - **Off:** Disables the network recording failover.
 - **Always:** Records video continuously regardless of the recording schedule until recording using a remote program works.
 - **On SD Schedule:** Records video according to the recording schedule set in the **Schedule** tab until recording using a remote program works.

NOTES:

- Searching and playing back video recorded on the SD memory card is supported by using a remote program. Refer to the User's Manual for the remote program for details.
- Searching and playing back video recorded on the SD memory card might not be very smooth when using a remote program while also recording video on the SD memory card.

CAUTION: When removing the SD memory card, uncheck the *Record* box first and wait for about 30 seconds before removing it. Removing the SD memory card while images are being recorded on the SD memory card or within 30 seconds after recording stops might damage the system and saved data.

Event

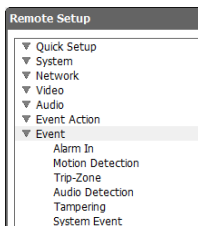

You can set up event detection function.

Alarm In

IR LED Supported Model

The screenshot shows the 'Remote Setup' dialog box for an IR LED supported model. The left sidebar lists various setup categories, with 'Event' expanded to show 'Alarm In' selected. The main area is titled 'EVENT / ALARM IN' and contains the following settings:

- Alarm In
- Title: Alarm In
- Type: NO
- Event Action section:
 - Alarm Out
 - Send Email
 - Remote Callback
 - Audio Alarm
 - FTP Upload
 - Record
 - Image Attachment
 - Image Attachment options: 1 2 3 4 5
 - Audio Alarm dropdown menu

*Event Action should be set for normal operation.

Buttons: OK, Cancel, Apply

IR LED Non-Supported Model

The screenshot shows the 'Remote Setup' dialog box for an IR LED non-supported model. The left sidebar is identical to the previous model, with 'Alarm In' selected. The main area is titled 'EVENT / ALARM IN' and contains the following settings:

- Alarm In
- Title: Alarm In
- Type: NO
- Event Action section:
 - Day & Night Mode
 - Alarm Out
 - Send Email
 - Remote Callback
 - Audio Alarm
 - FTP Upload
 - Record
 - B&W Mode
 - Image Attachment
 - Image Attachment options: 1 2 3 4 5
 - Audio Alarm dropdown menu

*Event Action should be set for normal operation.

Buttons: OK, Cancel, Apply

Check the **Alarm In** box to set up an alarm-in event. When the camera senses an input on the alarm input connector, it considers it as an event.

- **Title:** Enter the alarm-in device's name.
- **Type:** Select the alarm-in type.
- **Event Action:** Check the box for each action the camera will take whenever it detects an alarm-in event.
 - **Day & Night Mode:** Check the box to disable the IR cut filter during the event detection (not supported for IR LED supported model). Checking the box disables the **Day & Night Mode** feature set during the **Video – Camera** setup. Selecting **B&W Mode** enables the black and white mode during the event detection. When the event detection is expired, the IR cut filter is enabled and the black and white mode is disabled.
 - **Alarm Out:** Check the box to trigger an alarm-output signal.
 - **Send Email:** Check the box to send an email. Selecting **Image Attachment** attaches an event detected image file (.JPG) to the email.
 - **Remote Callback:** Check the box and select the remote systems to send a message (Not supported for the WebGuard program).
 - **Audio Alarm:** Check the box and select the audio file (.wav) to sound.
 - **FTP Upload:** Check the box to upload images to an ftp server.
 - **Record:** Check the box to record video.

NOTE: You must properly configure the settings related to each event action when setting them up to enable event actions. Refer to the *Event Action* setup.

Motion Detection

The screenshot shows the 'Remote Setup' dialog box with the 'EVENT / MOTION DETECTION' section selected. The left sidebar shows a tree view with 'Event' expanded and 'Motion Detection' selected. The main area contains the following settings:

- Motion Detection
- Sensitivity: Daytime 3, Nighttime 3
- Minimum Blocks for Dete...: Daytime 1, Nighttime 1
- Motion Zone: Setup... (330 Block(s))
- Motion Ignoring Interval: 2 sec.
- Daytime: 09:00 ~ 18:00





The 'Event Action' section includes:

- Alarm Out
- Send Email
- Remote Callback
- Audio Alarm
- FTP Upload
- Record
- Image Attachment (with options 1, 2, 3, 4, 5)

*Event Action should be set for normal operation.

Buttons: OK, Cancel, Apply

Check the **Motion Detection** box to set up a motion detection event. When the camera detects a motion in a configured motion detection zone, it considers the motion as an event.

- **Sensitivity:** Set the motion sensitivity for daytime and nighttime independently. The higher the number is, the more sensitive it is.
- **Minimum Blocks for Detection:** Adjust the minimum number of detection blocks that must be activated in order to be considered as a motion event for daytime and nighttime independently.
- **Motion Zone:** Click the **Setup...** button and a motion detection zone setup screen appears. Define the area (max. four) of the image that you want to set up a motion detection zone by using the motion detection zone icons.
 -  (Select) or  (Clear): Click to select or clear a block for motion detection. You can select or clear the several blocks of an area using the mouse dragging.
 -  or  (One or All block): Click to select or clear one or all blocks at a time.
 -  (Area): Click to select or clear several blocks of an area.
- **Motion Ignoring Interval:** Select the motion ignoring dwell time from the drop-down list. The camera will not log or send notifications of motion events occurring during the preset interval after a motion is detected. You can control excessive event logging and remote notifications of motion detection events by adjusting the motion ignoring dwell intervals.
- **Daytime:** Set up the daytime range. The camera will consider the remaining time range as the nighttime.
- **Event Action:** Check the box for each action the camera is to take when it detects a motion detection event.
 - **Alarm Out:** Check the box to trigger an alarm-output signal.
 - **Send Email:** Check the box to send an email. Selecting **Image Attachment** attaches an event detected image file (.JPG) to the email.
 - **Remote Callback:** Check the box and select the remote systems to send a message (Not supported for the WebGuard program).
 - **Audio Alarm:** Check the box and select the audio file (.wav) to sound.
 - **FTP Upload:** Check the box to upload images to an ftp server.
 - **Record:** Check the box to record video.

NOTE: You must properly configure the settings related to each event action when setting them up to enable event actions. Refer to the *Event Action* setup.

Trip-Zone

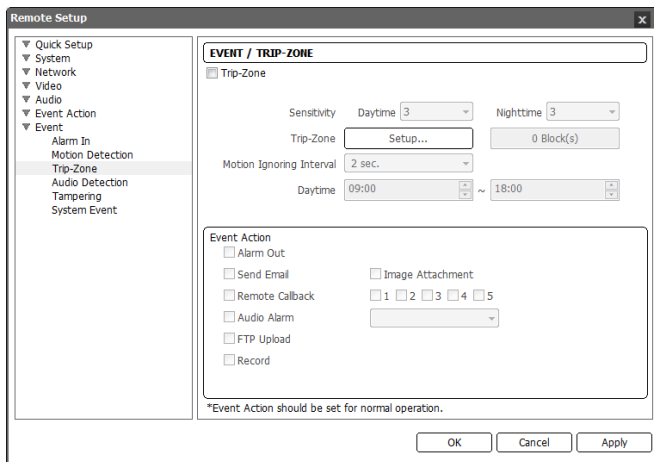

Check the **Trip-Zone** box to set up a trip-zone event. When the camera detects a moving to or from the preset trip-zone, it considers the moving as an event.

- **Sensitivity:** Set the moving sensitivity for daytime and nighttime independently. The higher the number is, the more sensitive it is.
- **Trip-Zone:** Click the **Setup...** button and a trip-zone setup screen appears. Define the area (max. four) of the image that you want to set up a trip-zone by using the trip-zone icons.
 - (Select) or (Clear): Click to select or clear a block for motion detection. You can select or clear the several blocks of an area using the mouse dragging.
 - or (One or All block): Click to select or clear one or all blocks at a time.
 - (Area): Click to select or clear several blocks of an area.
 - **Trip Direction:** Select the direction of the moving to be considered as an event. Selecting **In** considers a moving as an event when the moving to the area is detected, and selecting **Out** when the moving from the area is detected.
- **Motion Ignoring Interval:** Select the motion ignoring dwell time from the drop-down list. The camera will not log or send notifications of motion events occurring during the preset interval after a motion is detected. You can control excessive event logging and remote notifications of motion detection events by adjusting the motion ignoring dwell intervals.
- **Daytime:** Set up the daytime range. The camera will consider the remaining time range as the nighttime.
- **Event Action:** Check the box for each action the camera is to take when it detects a trip-zone event.
 - **Alarm Out:** Check the box to trigger an alarm-output signal.
 - **Send Email:** Check the box to send an email. Selecting **Image Attachment** attaches an event detected image file (.JPG) to the email.

- **Remote Callback:** Check the box and select the remote systems to send a message (Not supported for the WebGuard program).
- **Audio Alarm:** Check the box and select the audio file (.wav) to sound.
- **FTP Upload:** Check the box to upload images to an ftp server.
- **Record:** Check the box to record video.

NOTE: You must properly configure the settings related to each event action when setting them up to enable event actions. Refer to the *Event Action* setup.

Audio Detection

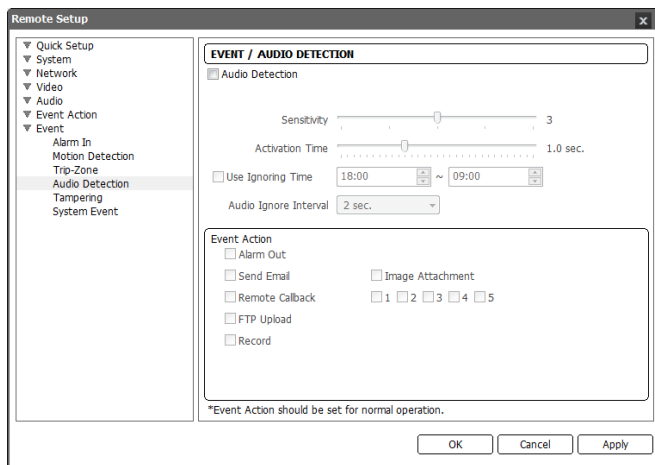

Check the **Audio Detection** box to set up an audio detection event. When the camera detects audio during the preset activation time, it considers it as an event.

- **Sensitivity:** Set the audio sensitivity. The higher the number is, the more sensitive it is.
- **Activation Time:** Adjust the duration that audio should last to be considered as an audio-in event. The camera will not consider any audio as an audio-in event if it lasts less than the preset time.
- **Use Ignoring Time:** Set up the event ignoring time. The camera will not consider audio that occurs during the preset time span as an event.
- **Audio Ignoring Interval:** Select the audio ignoring dwell time from the drop-down list. The camera will not log or send notifications of audio events occurring during the preset interval after an audio is detected. You can control excessive event logging and remote notifications of audio detection events by adjusting the audio ignoring dwell intervals.
- **Event Action:** Check the box for each action the camera is to take when it detects an audio-in event.
 - **Alarm Out:** Check the box to trigger an alarm-output signal.

- **Send Email:** Check the box to send an email. Selecting **Image Attachment** attaches an event detected image file (.JPG) to the email.
- **Remote Callback:** Check the box and select the remote systems to send a message (Not supported for the WebGuard program).
- **FTP Upload:** Check the box to upload images to an ftp server.
- **Record:** Check the box to record video.

NOTE: You must properly configure the settings related to each event action when setting them up to enable event actions. Refer to the *Event Action* setup.

Tampering

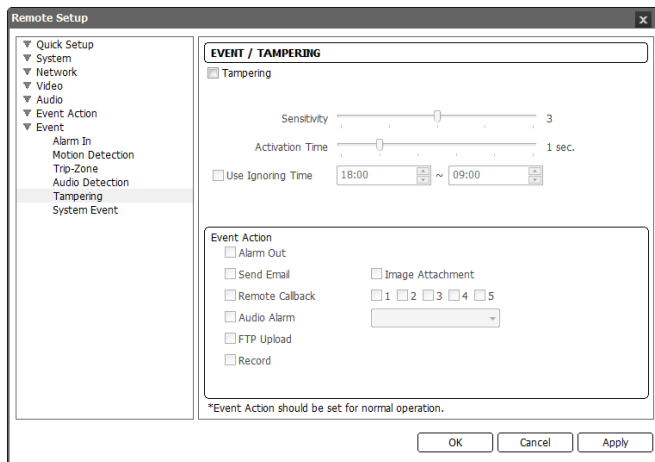

Check the **Tampering** box to set up a tampering detection event. When a radical change is detected in video (for example, the camera is moved, lens is blocked, etc), it considers it as an event.

- **Sensitivity:** Set the tampering sensitivity. The higher the number is, the more sensitive it is.
- **Activation Time:** Adjust the duration that tampering should last to be considered as a tampering event. The camera will not consider any tampering as a tampering event if it lasts less than the preset time.
- **Use Ignoring Time:** Set up the event ignoring time. The camera will not consider tampering that occurs during the preset time span as an event.
- **Event Action:** Check the box for each action the camera is to take when it detects a tampering.
 - **Alarm Out:** Check the box to trigger an alarm-output signal.
 - **Send Email:** Check the box to send an email. Selecting **Image Attachment** attaches an event detected image file (.JPG) to the email.

- **Remote Callback:** Check the box and select the remote systems to send a message (Not supported for the WebGuard program).
- **Audio Alarm:** Check the box and select the audio file (.wav) to sound.
- **FTP Upload:** Check the box to upload images to an ftp server.
- **Record:** Check the box to record video.

NOTE: You must properly configure the settings related to each event action when setting them up to enable event actions. Refer to the *Event Action* setup.

System Event

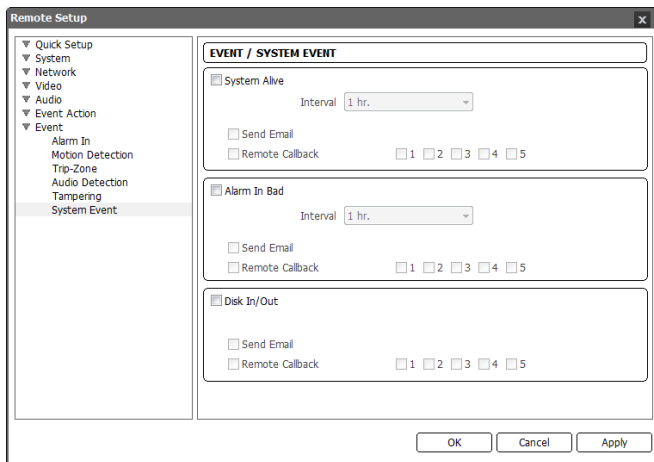

Check the **System Event** box to set up a system event. The camera checks and reports the system and alarm-in status and SD memory card on or off.

- **System Alive:** Check the box to check the system operation, and select the check interval.
 - **Send Email:** Check the box to send an email when the system is operating.
 - **Remote Callback:** Check the box and select the remote systems to send a message when the system is operating (Not supported for the WebGuard program).
- **Alarm In Bad:** Check the box to check the alarm-in operation and select the check interval.
 - **Send Email:** Check the box to send an email when there is no change of alarm-in event status.
 - **Remote Callback:** Check the box and select the remote systems to send a message when there is no change of alarm-in event status (Not supported for the WebGuard program).
- **Disk In/Out:** Check the box to send notices if an SD memory card is inserted or removed.
 - **Send Email:** Check the box to send an email when the SD memory card is inserted to or removed from the camera.

- **Remote Callback:** Check the box and select the remote systems to send a message when the SD memory card is inserted to or removed from the camera (Not supported for the WebGuard program).

NOTE: You must properly configure the *Email* and *Remote Callback* settings when setting them up to send an email or a message. Refer to the *Event Action* setup.

Chapter 4 — WebGuard

You can monitor live video images from the camera or search recorded image saved in the SD memory card on the web browser by using the WebGuard program.

Computer system requirements for using WebGuard are:

- Operating System: Microsoft® Windows® XP (Service Pack 3), Microsoft® Windows® Vista (Service Pack 1), Microsoft® Windows® 7 (Home Premium, Professional, Ultimate) or Microsoft® Windows® 8 (Pro, Enterprise)
- CPU: Intel Pentium III (Celeron) 600MHz or faster (Core 2 Duo E4600 recommended)
- RAM: 128MB or more (2GB recommended)
- VGA: 8MB or more (128MB recommended) (1024x768, 24bpp or higher)
- Internet Explorer: Version 6.0 or later 32-bit

Start Internet Explorer on your local PC. You can run the WebGuard program by entering the following information in the address field.

- “http://IP address:port number”
(The camera IP address and the WebGuard port number set during the port setup)
- Or, “http://DVRNS server address/camera name”
(The DVRNS server address and the camera name registered on the DVRNS server)

NOTES:

- Enter *https* instead of *http* if you have checked the *Use HTTPS* box during the WebGuard port number setup. Click *Continue to this website (not recommended)* when the security certificate warning page is displayed. When the WebGuard login page is not displayed, check Internet option settings as follows:
 - Go to *Tools*, then *Internet Options*, and then the *Security* tab → Click the *Custom level...* button → Set the setting of *Reset custom settings to Medium-high (default)* or *Medium*.
 - Go to *Tools*, then *Internet Options*, and then the *Advanced* tab → Check the *Use TLS 1.0* box under the *Security* option.
- You do not need to enter the WebGuard port number if the WebGuard port number is set to 80 (443 when entering *https*) when running the WebGuard program by entering the IP address and port number.

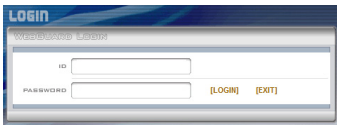

Enter your ID and PASSWORD and click the [LOGIN] button.

NOTES:





- WebGuard only works with Microsoft Internet Explorer and will NOT work with other web browsers.
- WebGuard does not work with Microsoft® Windows® 8 metro UI.

NOTES:

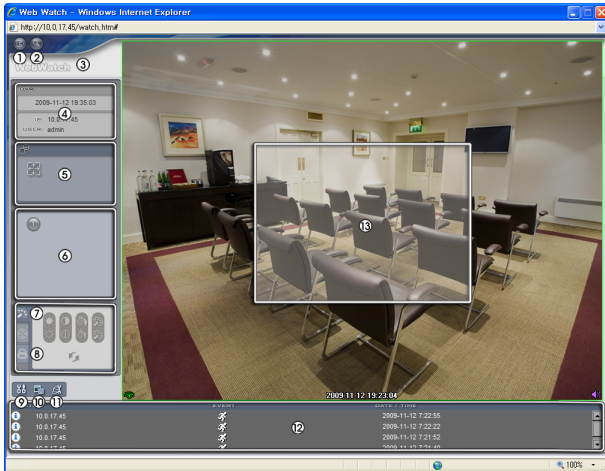

- Do NOT close the LOGIN window during the WebGuard operation, otherwise, it will cause a script error when switching between Web monitoring and Web search modes, and you will need to restart the WebGuard program.
- There might be a problem with the bottom of the WebGuard page being cropped caused by the address or status bars. In this situation, it is recommended that websites open windows without address or status bars by changing Internet setting. (Go to *Tools*, and *Internet Options*, and then the *Security* tab → Click the Custom level... button → Select *Enable* for the *Allow websites to open windows without address or status bars* option.)
- When running WebGuard in the Microsoft® Windows® Vista or later operating system, it is recommended that you start Internet Explorer with elevated administrator permissions. Click the right mouse button on the Internet Explorer icon and select the *Run as administrator* option from the context menu. Otherwise, some functions of WebGuard might be limited.
- There might be a problem with screen display or screen update caused by low image transmission speed when using the Microsoft® Windows® Vista or later operating system. In this situation, it is recommended that you disable the Auto Tuning capability of your computer. Run the *Command Prompt* with elevated administrator permissions (Go to the *Start* Menu, and *Accessories*, and then *Command Prompt* → Click the right mouse button and select the *Run as administrator* option). Then enter “netsh int tcp set global autotuninglevel=disable” and press the enter key. Restart your computer to apply the changes. If you want to enable the Auto Tuning capability again, enter “netsh int tcp set global autotuninglevel=normal” after running the *Command Prompt* with elevated administrator permissions. Restart your computer to apply the changes.
- When running the updated WebGuard for the first time, Internet Explorer might occasionally load the information from the previous version. In this case, delete the temporary Internet files by selecting *Tools* → *Internet Options* → *General* tab, and then run WebGuard again.
- You will need to get the appropriate IP address for the camera you want to connect to and the WebGuard port number from your network administrator.

Web Monitoring Mode

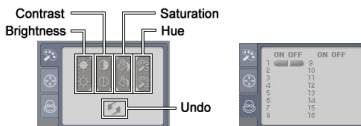

- ① **Log Out:** Click  to log out of the WebGuard program.
- ② **Search:** Click  to access to the web search mode.
- ③ **Version:** Position the mouse pointer on the WebWatch logo to see the WebGuard program version.
- ④ **Information:** The Information window displays the login information of WebGuard.
- ⑤ **Full Display:** Clicking the button displays the video in full screen. Pressing the Esc button on a keyboard returns to the previous screen.
- ⑥ **Camera Button:** The button displays the camera number.
- ⑦ **Image Adjustment:** Click  to adjust the brightness, contrast, saturation and hue of monitored image.
- ⑧ **Alarm-Out Control:** Click  to control an alarm out device remotely.



- ⑨ **Setup:** Click  to set up the image drawing mode and OSD display. You can adjust the display speed by changing the image drawing mode, and select OSD information to be displayed on the screen.
- ⑩ **Save Image:** Click  to save the current image as a bitmap or JPEG file format.
- ⑪ **Remote Setup:** Click  to change the settings of the camera by using the Remote Setup screen.

- ⑫ **Event Status Window:** The event status window at the bottom displays a list of events that were detected in the camera.

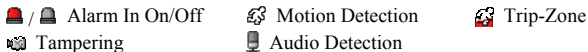

- ⑬ **Screen Popup Menu:** Clicking the right mouse button on the screen displays the screen popup menu.

Change Camera Title	
Enable Audio	
Aspect Ratio	▶
MultiStream	▶
Anti-Aliasing Screen	







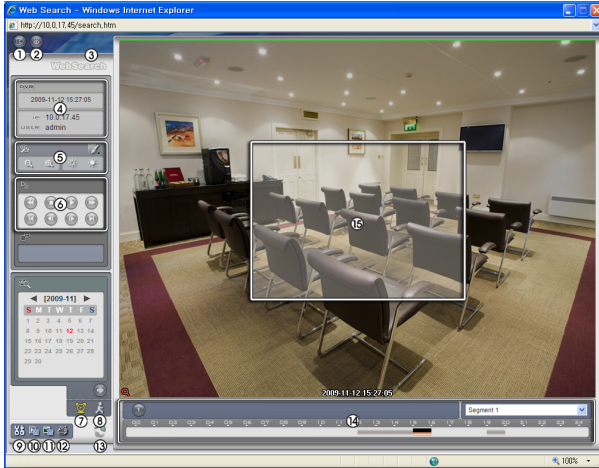

- **Change Camera Title:** Select to change the camera title.
- **Enable Audio:** Select to enable audio communication with the site which the camera is installed and the audio control panel appears. Click the button to send audio to the site which the camera is installed and speak into the microphone. Click the button to monitor live audio from the site which the camera is installed through the attached speaker. Clicking both the and buttons allows two-way communication. Clicking the button disables audio communication.
- **Aspect Ratio:** Select to change the image aspect ratio displayed on the screen and the option menu appears. Selecting **Fit to Screen** displays images by fitting them to the screen size. Selecting **Original Ratio** displays images by fitting them to the screen size while maintaining their original ratio. Selecting **Half Size (x0.5)** to **Quadruple Size (x4)** displays the images at the selected image size.
- **Multistream:** Select to choose the desired stream if the camera is in multistream mode.
- **Anti-Aliasing Screen:** Select to enhance image display quality by eliminating stair stepping (aliasing) effects in the enlarged image.

NOTES:





- The image adjustment for the monitoring screen works only in the pause mode.
- A camera name change in the Web Watch mode does not affect the camera name set up on the camera. Leaving the Camera Title blank causes the camera name set up on the camera to display.
- *Aspect Ratio – Half Size (x0.5) to Aspect Ratio to Quadruple Size (x4)* in the Screen Popup Menu will be enabled when the selected camera screen can display images in those sizes.

Web Search Mode

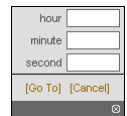

- ① **Log Out:** Click  to log out of the WebGuard program.
- ② **Watch:** Click  to access to the web monitoring mode.
- ③ **Version:** Position the mouse pointer on the WebSearch logo to see the WebGuard program version.
- ④ **Information:** Displays the login information of WebGuard.
- ⑤ **Playback Image Control:** Click  to blur, sharpen, equalize and interpolate playback images. Click  to zoom out or zoom in the recorded image. Click  to adjust the brightness of the recorded images.
NOTE: Image processing works only in the pause mode.
- ⑥ **Playback Control:** Click the desired button to play recorded video. The following functions are supported: fast backward, pause, play, fast forward, go to the first image, go to the previous image, go to the next image, and got to the last image.
- ⑦ **Time-Lapse Search:** Click  to enter the time-lapse search mode which allows you to search for recorded data by time and then play back images found within the time parameters. The Timetable window located at the bottom displays the time information for the image of the date selected on the calendar. If the camera has more than one video segment in the same time range, you can select the video segment you want to search. Clicking a specific time displays the image recorded at that time on the screen. Selecting  allows you to display an image from a specific time.
- ⑧ **Event Search:** Click  to enter the event search mode which allows you to search for event log entries using specific conditions and play back the images associated with those event entries.



- ⑨ **Setup:** Click  to set up the image drawing mode and OSD display. You can adjust the display speed by changing the image drawing mode, and select OSD information to be displayed on the screen.
- ⑩ **Save Video:** Click  to save any video clip of recorded data as a video file.
- ⑪ **Save Image:** Click  to save the current image in a bitmap or JPEG file format.
- ⑫ **Print:** Click  to print the current image on a printer connected to your computer.
- ⑬ **Reload:** Click  to reload the recording data.
- ⑭ **Timetable:** Displays recorded data of the camera by time (in hour segments). If the camera's time and date have been reset to a time that is earlier than some recorded video and more than one video segment exists in the same time range, select the video segment you want to search from the SEGMENT menu at the top-right corner on the timetable.
- ⑮ **Screen Popup Menu:** Clicking the right mouse button on the screen displays the screen popup menu.



- **Change Camera Title:** Select to change the camera title.
- **Enable Audio:** Plays audio while playing back recorded video that has recorded audio.
- **Aspect Ratio:** Changes the image aspect ratio.
- **Anti-Aliasing Screen:** Select to enhance image display quality by eliminating stair stepping (aliasing) effects in the enlarged image.

NOTE: A camera name change in the Web Search mode does not affect the camera name set up on the camera. Leaving the Camera Title blank causes the camera name set up on the camera to display.

Appendix

LED Indicators

LED Status		Description
Power LED	Unlit	No power connected to the unit.
	Flicker	The unit is booting.
	Lit	The unit is operating.
Network LED	Lit	The unit is connected to a network.
Power LED & Network LED	Flicker sequentially	The unit is upgrading the software.

Connector Pin Outs

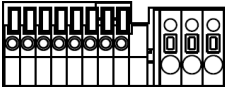

Alarm	GND	GND (Frame Ground)
	OUT	Alarm Out (Active Low – Open Collector output)
	IN	Alarm Input
Audio	GND	GND (Frame Ground)
	OUT	Audio Out
	IN	Audio In
Video	GND	GND (Frame Ground)
	CVBS	Video Output
Power	DC12V +	Power In (power polarity is distinguished)
	DC12V –	
	FGND	Frame GND

Map of Screens (Remote Setup)

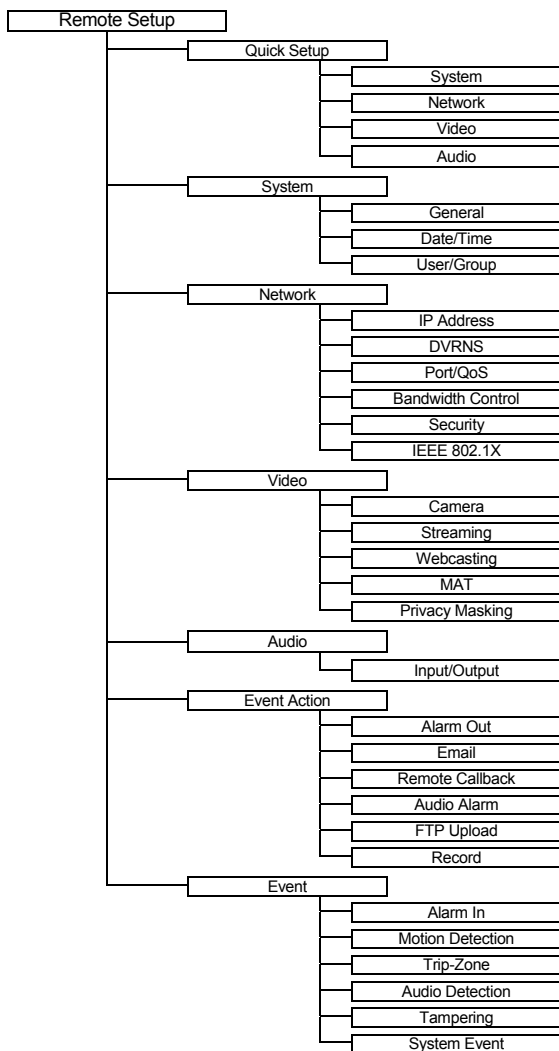

Troubleshooting

Problem	Possible Solution
No Power	<ul style="list-style-type: none"> Check power cord connections. Confirm that there is power at the outlet.
PoE switch is not recognized.	Check the ground status of the PoE switch and the connected input/output devices to the camera. If they are not grounded, use them after grounding.
No Live Video	<ul style="list-style-type: none"> Confirm that the camera has power. Check that the cable connection to the camera and lens is not loose. Check network connections on your PC and a camera.
Live video is not clear.	<ul style="list-style-type: none"> Check if there is dust or dirt on the lens and clean the lens with a clean cotton cloth or brush. Check that the focus is set correctly. Check that the lighting and adjust the camera position or angle if bright light is shining directly into the lens.
Video color appears incorrect.	Check that the white balance setting for the camera. When set to Auto , it might take awhile to adjust the white balance.
Video flickers.	Check to see if the camera points directly at the sun or a fluorescent light and adjust the camera's direction.
Connection to the INIT program is not available because of wrong ID and password.	If you lost the administrator ID and password, do a factory reset and customize all settings all over again. The factory reset returns all the settings including network settings to the original factory settings. Write down the password just in case.
The WebGuard program is not available.	If you cannot launch the login page of the WebGuard program, check Microsoft Internet Explorer's version. WebGuard might not run properly in versions earlier than 6.0.

Specifications

LENS	
Lens Type	Varifocal auto-iris (HD model: F1.6, Full HD model: F1.2)
Focal Length	HD model: 3.3mm to 12mm
	Full HD model: 3mm to 9mm
Angle View	HD model
	H: 109.0° (Wide) to 29.0° (Tele) V: 56.0° (Wide) to 15.0° (Tele) D: 122.0° (Wide) to 31.0° (Tele)
	Full HD model
	H: 123.0° (Wide) to 37.0° (Tele) V: 66.0° (Wide) to 22.0° (Tele) D: 131° (Wide) to 43° (Tele)
Lens Iris Control	DC auto-iris
Day/Night Filter	Yes

Specifications are subject to change without notice.

CAMERA	
Image Sensor	1/2.7" CMOS
Minimum Illumination	IR LED supported model: 0 Lux @ F 1.6 (30 IRE) 0 Lux @ F 1.2 (30 IRE)
	IR LED non-supported model: 0.5 Lux @ F 1.6 (30 IRE) 0.5 Lux @ F 1.2 (30 IRE)
Scanning Mode	Progressive scan
SNR	45 dB or higher
Dynamic Range (Digital WDR)	90 dB or higher
Electronic Shutter	Auto
IR LED (IR LED supported model only)	LED x 18 (850 nm)
Illumination Sensor	Yes (IR LED supported model only)
IR Working Distance (IR LED supported model only)	20 m
External Storage ¹ (Optional)	Micro SD (SDHC) memory card (class 6 or higher, max. 32GB)

¹ SLC (Single Level Cell) or MLC (Multi Level Cell) types of SanDisk or Transcend brands are recommended for stable recording.

¹ SD memory cards are expendable supplies. After a certain use in time, partial memory sectors can be damaged and recording may not be available or data will be lost. Check the SD memory card periodically and replace it with a new one if necessary.

VIDEO	
Video Signal	NTSC or PAL (programmable)
Compression Algorithm	H.264, M-JPEG (Four levels)
Compression Resolution	HD model: CIF (352x240), 4CIF (704x480), 720p (1280x720)
	Full HD model: CIF (352x240), 4CIF (704x480), 720p (1280x720), 1080p (1920x1080)
Bitrate Control	HD model: H.264 –CBR / VBR (up to 8 Mbps)
	Full HD model: H.264 –CBR / VBR (up to 12 Mbps)
Maximum Frame Rate (images per second)	HD model: 30 ips @ 720p + 15 ips @ 720p
	Full HD model: 30 ips @ 1080p + 4 ips @ 1080p
Multistream	Primary, Secondary, Tertiary
AUDIO	
Compression Algorithm	G.726 (16KHz), G.711 μ – Law (8KHz)

Specifications are subject to change without notice.

INPUTS/OUTPUTS	
Video Output ⁱⁱ	1 Composite, 1 Vp-p
Audio Input	1 line in
Audio Output	1 line out
Alarm Input	1 TTL, NC/NO programmable, 4.3V (NC) or 0.3V (NO) threshold, 5 VDC
Alarm Output	1 TTL open collector, 30mA @ 5 VDC
Network Connectivity	10/100 Mbps Ethernet

ⁱⁱ It is intended for video preview while adjusting the camera.

CONNECTORS	
Video Output ⁱⁱⁱ	Terminal block
Audio In/Out	Terminal block (mono)
Alarm In/Out	Terminal block
Ethernet Port	RJ-45

ⁱⁱⁱ It is intended for video preview while adjusting the camera.

GENERAL	
Dimensions (Ø x H)	6.3" x 4.8" (159mm x 122mm)
Shipping Dimensions (W x H x D)	8.1" x 6.9" x 8.1" (205mm x 175mm x 205mm)
Unit Weight	Vandal dome model: 1.9 lbs. (0.87kg)
	Plastic dome model: 1.1 lbs. (0.51kg)
Shipping Weight	Vandal dome model: 2.6 lbs. (1.18kg)
	Plastic dome model: 1.8 lbs. (0.82kg)
Operating Temperature	Heater non-supported model: 14°F to 122°F (-10°C to 50°C) (Boot up temperature: 32°F to 122°F (0°C to 50°C))
	Heater supported model: -4°F to 122°F (-20°C to 50°C)
Operating Humidity	0% to 90%
Power Supply	12 VDC, PoE (Power over Ethernet) (IEEE 802.3af, Class 2)
Power Consumption	Max. 4.8W (Max. 19.2W when the heater is operating)
Approval	FCC, CE, IP66 ^{iv}

^{iv} The IP66-level is supported for the models that O-ring is seated in a groove of bottom cover.

Specifications are subject to change without notice.

Index

A		N	
Admin/Watch/Record/Search Port.....	20	Network Bandwidth Limit	22
B		O	
Bitrate Control	31	ONVIF Protocol	14
C		Q	
Camera Name	14, 19	Quality	31
Compression	31, 33	R	
D		Resolution	31
Date/Time	15	RTSP Port	20
DSCP	20	S	
DVR Name Service	19	SSL	23
DVRNS Server	19	T	
F		Time Sync.....	16
Frame Rate	32	U	
I		Use HTTPS	20
IP Filtering	23	Use UPnP.....	21
M		User/Group.....	16
MAT	34	W	
		WebGuard Port.....	20