

ANPR LUMO

installation guide

2022-10-10 | v1.14 | Doc. no. 5286778



Copyright

Copyright © Nedap N.V. All rights reserved. The information in this document is subject to change without notice, it is not to be reproduced in any way, in whole or in part, without the written consent of Nedap N.V. All trademarks referenced belong to their respective owners

Disclaimer

Nedap N.V. has made every effort to ensure the accuracy of the information contained in this document. However, Nedap N.V. makes no representations or warranties whatsoever whether express or implied as to the accuracy, correctness, completeness or fit-for-purpose or suitability for the purpose of this product. You use the products at your own risk. Nedap N.V. excludes any liability to the maximum extent permitted by applicable law for the damages caused by errors or failures made during the installation or improper use of this product or by not applying the instructions stated in this document.

Nedap N.V. reserves the right to make improvements or amendments to this document and/or the products described therein at any time without any notification. The latest version of this document can be found on our partner portal <https://portal.nedapidentification.com>. Please download the latest version of this document and keep a copy for your own records.

This document can be published in various languages but only the English language version will prevail. Nedap N.V. assumes no responsibility for any errors caused for the translations into another language.

Warranty and spare parts

Please consult the Nedap products dealer from whom you purchased this product, in regards to the applicable warranty conditions. This product cannot be used for any other purpose as described in this document. If the product is not installed according to this document; the warranty provided is not applicable. At the sole discretion of Nedap N.V., Nedap N.V. may decide to change the conditions of the warranty policy. You agree that Nedap N.V. is able to compensate you the pro-rata value of the warranty involved rather than replacing or repairing the product depending on the technical or economical value of the product.

Prior to applying the warranty, please verify if you comply with the warranty conditions of the warranty policy, whether you can successfully apply for the replacement or repair of a defective part. Parts can only be replaced with original Nedap parts, otherwise the warranty policy will not be applicable on the product. If the warranty is applicable, please contact the dealer or send the defective parts to the dealer.

Additional information

For any information or questions regarding the product, please contact your own dealer.

Nedap N.V.
Identification Systems
Parallelweg 2
7141 DC Groenlo
The Netherlands

+31 (0)544 471 111
info@nedapidentification.com
www.nedapidentification.com

Contents

1	Introduction	6
1.1	Typical applications	6
1.2	Key features	6
2	Getting started	7
2.1	Mounting the ANPR LUMO	7
2.2	Connecting the ANPR	7
2.3	Assigning an IP-address	7
2.4	Testing the ANPR	7
3	Installation	8
3.1	Safety precautions	8
3.2	Mounting	8
3.2.1	Pole mounting	8
3.2.2	Behind barrier mounting	9
3.3	Dimensions	9
4	Connections	11
4.1	Ethernet connection	11
4.2	Power supply	11
4.3	RS485 connection	11
4.4	Wiegand connection	11
4.5	Digital I/O	11
5	OSDP	12
5.1	Requirements	12
5.2	Connections	12
5.3	Configuration	12
5.4	Plate reading messages	12
5.5	Relay outputs	12
5.6	Digital inputs	13
5.7	OSDP capabilities	13
6	Configuration	14
6.1	Using the web server	14
6.2	Menu Items	15
6.2.1	Home	15
6.2.2	Text results	16
6.3	Access list	17

- 6.3.1 Wiegand matchlist 19
- 7 Configuration menus 21
 - 7.1 CAMERA 21
 - 7.2 ANPR 23
 - 7.2.1 TRIGGER MODES 25
 - 7.2.2 MODE OF OPERATION 28
 - 7.2.3 ENGINE 30
 - 7.2.4 ACCESS 32
 - 7.3 ACTIONS 33
 - 7.3.1 DIGITAL OUT 33
 - 7.3.2 FTP UPLOAD 34
 - 7.3.3 FTP DATABASE 34
 - 7.3.4 STORE 34
 - 7.3.5 HTTP ACTION 35
 - 7.3.6 HMAC HTTP ACTION 35
 - 7.3.7 TCP ACTION 35
 - 7.3.8 SERIAL 35
 - 7.3.9 SERIAL OSDP 36
 - 7.3.10 MQTT 36
 - 7.3.11 WIEGAND 26 36
 - 7.3.12 WIEGAND 64 36
 - 7.3.13 WIEGAND MATCHLIST 37
 - 7.4 Installation parameters 39
- 8 SYSTEM SETTINGS 40
 - 8.1 NETWORK 40
 - 8.1.1 NETWORK SETTINGS 40
 - 8.1.2 TIME SETTINGS 40
 - 8.2 USERS 41
 - 8.3 CLASSIFIER 41
 - 8.4 SYSTEM 41
 - 8.4.1 SYSTEM MANAGEMENT 41
 - 8.4.2 LIBRARY VERSION 43
 - 8.4.3 DIGITAL IO 43
- A Message placeholders 44
- B Disposal of equipment 45
- C CE - UKCA declaration 45

D Document revision 45

1 Introduction

The NEDAP ANPR LUMO License Plate Reader offers automatic number plate reading. The NEDAP ANPR LUMO is an all in one camera including camera, analyzer and IR illuminator. The ANPR has embedded processing software onboard. The License Plate Reader is default featured with RS485, Wiegand and Ethernet communication.

1.1 Typical applications

Typical applications include parking, crime prevention, toll systems, security and access control, logistics and customs. In addition the NEDAP ANPR LUMO can be applied in applications where it is difficult to issue RFID tags.

1.2 Key features

- Automatic number plate reading.
- All-in-one system including camera, analyzer, IR illuminator.
- ANPR LUMO optimal performance in range from 2 to 10 meters.
- Easy user configuration (web server).
- TCP/IP Ethernet interface.
- RS485 serial interface.
- OSDP v2 supported including secure channel protocol.
- Wiegand 26 bit/64 bit.
- Wiegand match-list with custom Wiegand format.
- Digital inputs.
- Stand-alone operation supported by digital outputs and black-, white-, ignore list features.
- Advanced access lists features through regular expressions.
- Multiple regions of interest.
- Power over Ethernet.
- REST API.

2 Getting started

2.1 Mounting the ANPR LUMO

Determine how to mount the ANPR. The ANPR LUMO can be installed onto a pole or behind the barrier. Mount behind the barrier to ensure recognition right in front of the barrier.

Important mounting issues are:

- Best focus distance is between 2 and 10 meters [7 ... 26 ft].
- Angle between ANPR and number plate should be smaller than 25 degrees.

Mounting details are described in chapter 3.2.

2.2 Connecting the ANPR

The ANPR is delivered with 5m cables for power, I/O and network. Power supply, RS485 communication and I/O are combined in one cable. Ethernet network is a separate cable. The cables are pre-fitted to the ANPR. For installation the ANPR does not need to be opened. Connecting the power supply and network cable are required to configure the ANPR.

2.3 Assigning an IP-address

Enter the default IP-address in the address bar of your web browser.

Default IP address is:

IP address: 192.168.3.15

The login window appears where the user is asked to type the username and password.

Username: **admin**

Password: **secret**

Go to the system configuration and setup the network configuration as desired. If required, now also other configuration settings may be changed.

Note : The ANPR LUMO software interface is not compatible with Internet explorer

2.4 Testing the ANPR

Test the ANPR to check if it is aligned correctly and if it is able to read the license plates. Drive the vehicle into the position where it should be possible to read its license plate.

Connect to the ANPR using your web browser on the main page you can see the live video. On the right side of the page the text results are shown. It might be necessary to adjust the ANPR alignment.

3 Installation

3.1 Safety precautions

The following safety precautions must be observed during normal use, service and repair.

- The ANPR shall be connected to safety ground.
- Disconnect the power supply before removing any parts.
- The ANPR shall only be installed and serviced by qualified and trained personnel.
- To be sure of safety, do not modify or add anything other than mentioned in this manual or indicated by NEDAP N.V.
- CAUTION: for continued protection against risk of fire, replace fuses only with the same type and rating.
- The ANPR can be powered from a low power, Class 2 power supply, in compliance with local regulations or through PoE.
- The product is to be connected only to PoE networks without routing to the outside plant.
- The ANPR is equipped with an 850nm Infrared illuminator. The human eye will not or slightly see this light coming from the illuminator. Do not look into the ANPR lens directly from close range or for more than 100 seconds. Eyes can be damaged by not taking these precautions. During normal use of the ANPR at a vehicle gate, reading plates, there is no risk to the public.

3.2 Mounting

The ANPR is intended for vehicle access control. Vehicles are identified by the number plate when approaching the gate. Because the number plate recognition is very fast, a full stop is normally not necessary. The ANPR covers a reading distance of 2 to 8 meters. The field of view is typically one lane wide. There are 2 recommended positions for the ANPR.

3.2.1 Pole mounting

The ANPR is positioned directly behind or in front of the actual barrier onto a pole. In that case the ANPR can be best positioned on a pole at maximum 4 meter height. In this position the number plate of the vehicle directly in front of the barrier cannot be read anymore. So these vehicles need to be recognized in flow. Mounting the ANPR at 4 meter height is here the best option. When overhead installation is an option, the ANPR can at best be installed in the center of the lane, above the lane. Horizontal angle will be 0° in that case, which is good.

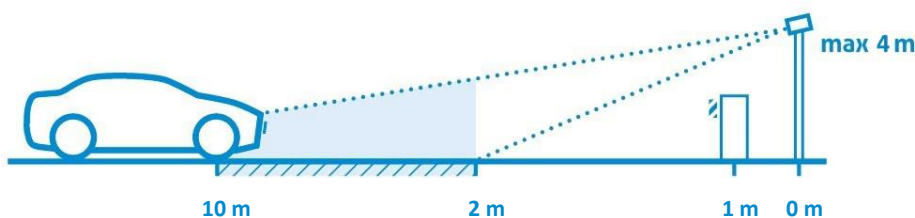

Figure 1: Pole mounting (ANPR LUMO)

3.2.2 Behind barrier mounting

The ANPR is positioned behind the barrier at bumper height.

If there is space behind the barrier and the sight is not blocked, then the best place for the ANPR is at bumper height (0.5m height) about 2 to 3 meters behind the barrier. A vehicle just in front of the barrier is still recognized in that case.

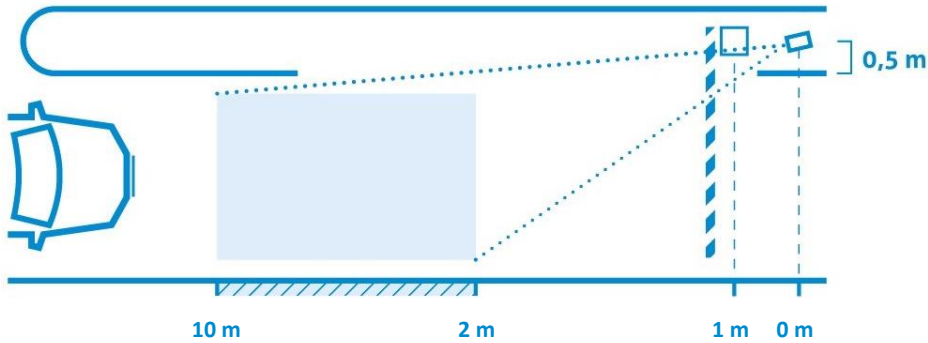

Figure 2: Behind the barrier mounting (ANPR LUMO)

3.3 Dimensions

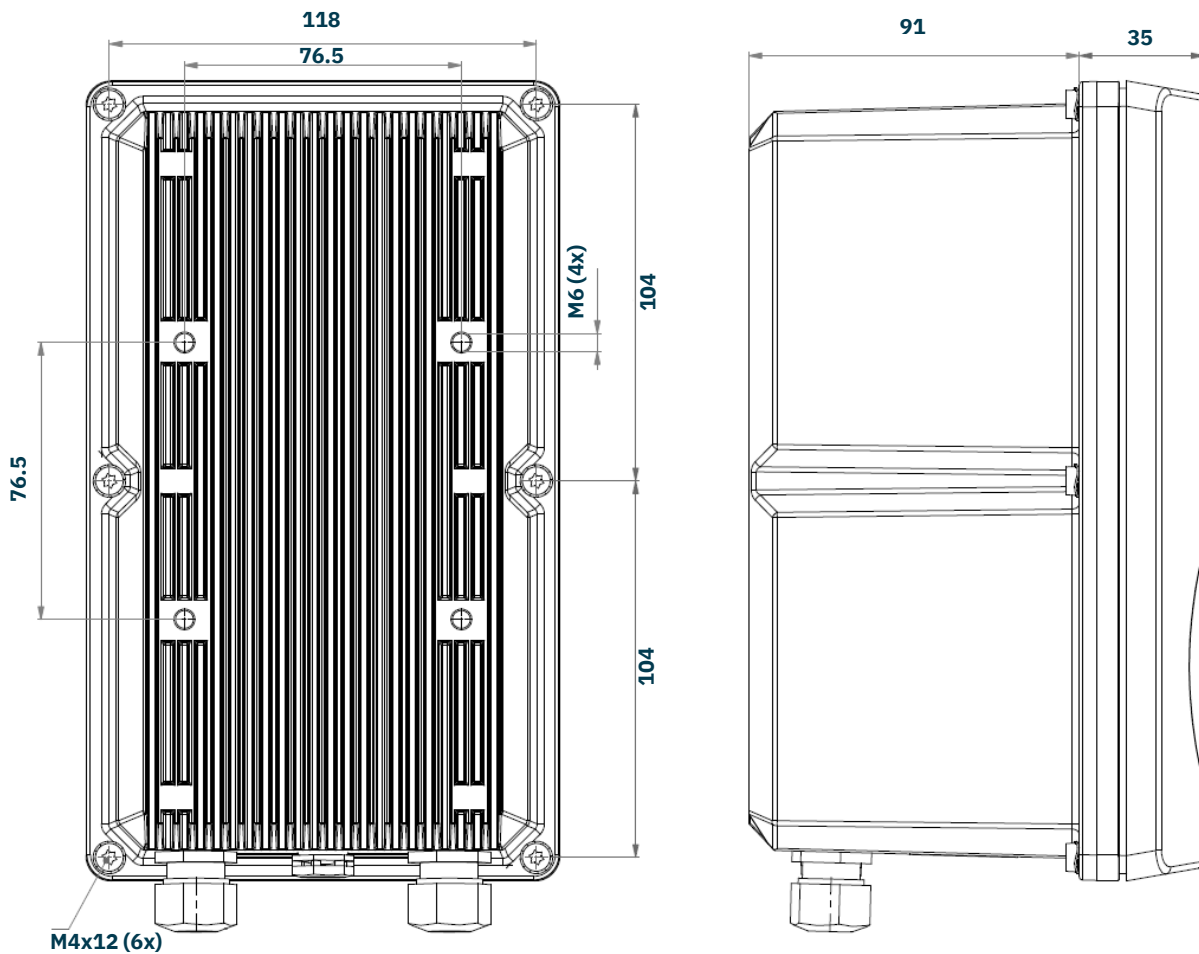

Figure 3: ANPR housing dimensions

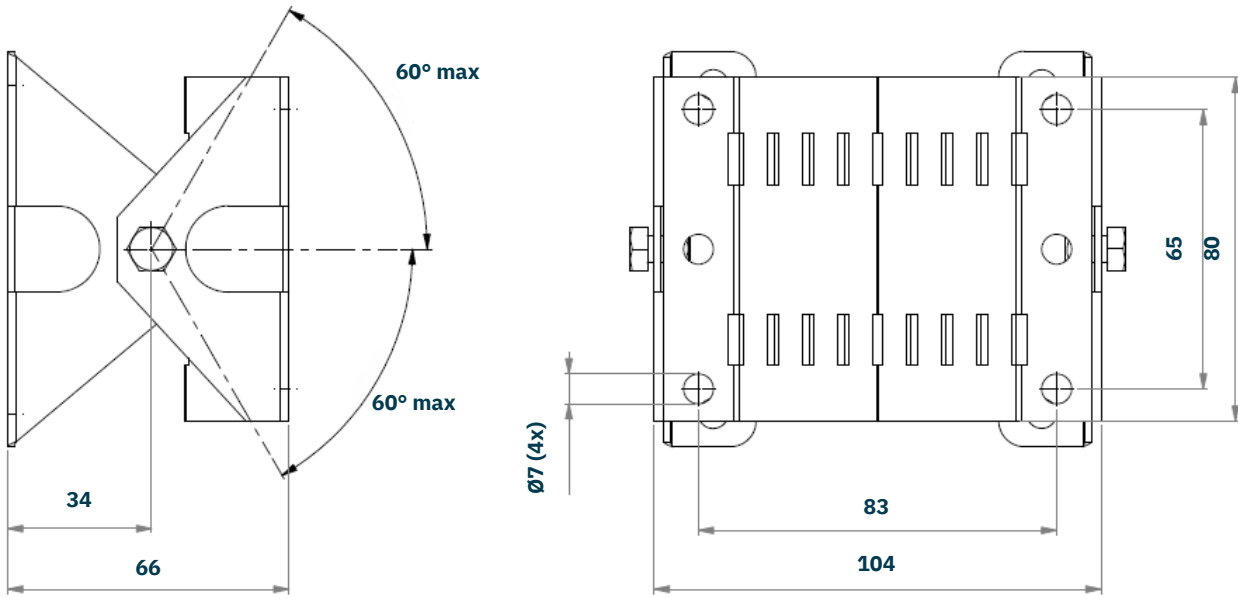

Figure 4: Mounting bracket dimensions

4 Connections

The ANPR is delivered with two 5m long cables. Power supply, RS485 communication and I/O are combined in one cable. Ethernet network is a second cable. The cables are pre-fitted to the ANPR. For installation the ANPR does not need to be opened.

4.1 Ethernet connection

The Ethernet cable is already fitted to the ANPR provided an RJ-45 connector. This Cat5e cable will be adequate for connection of the unit to a local area network. The ANPR LUMO can also be powered through Power Over Ethernet (802.3af or 802.3at).

4.2 Power supply

RED Power supply +24VDC ~ 1A

BLUE Ground 0V

BLACK Ground 0V

Note: the ANPR LUMO may also be powered through PoE (802.3af) or PoE+ (802.3at)

4.3 RS485 connection

YELLOW RS-485 A

GREEN RS-485 B

PURPLE RS-485 GND

4.4 Wiegand connection

WHITE Wiegand Data-0

BROWN Wiegand Data-1

PURPLE Wiegand GND

4.5 Digital I/O

PINK Digital input IN 1 + (optocoupler positive contact, U = 5 - 24VDC)

GRAY Digital input IN 1 -

GRAY/PINK Digital input IN 2 + (optocoupler positive contact, U = 5 - 24VDC)

RED/BLUE Digital input IN 2 -

WHITE/GREEN Relay output 1 (normally open contact, $U_{max} = 24VDC$, $I_{max} = 2A$).

BROWN/GREEN Relay output 1 (common contact).

WHITE/YELLOW Relay output 2 (normally open contact, $U_{max} = 24VDC$, $I_{max} = 2A$).

BROWN/YELLOW Relay output 2 (common contact).

5 OSDP

The ANPR LUMO support OSDP v2 , including the secure channel protocol.

5.1 Requirements

ANPR LUMO (art.no. 9986138) hardware revision A.05.

ANPR LUMO software v4.5.1 (or newer).

5.2 Connections

The OSDP communication is performed on the RS485 interface. See chapter 4.3 for a description of the RS485 connections. The communication can be connected in point-to-point or in multi-drop.

5.3 Configuration

Enable the OSDP communication in SYSTEM SETTINGS - SERIAL SETUP. See page 42.

Here you also set the OSDP baudrate, the OSDP device address and the secure protocol encryption key (SCBK).

5.4 Plate reading messages

Ensure that you enable a SERIAL-OSDP action upon a READ-event. See page 36.

The ANPR LUMO will send an OSDP_RAW message including the message data. The data report will be sent in response to a poll command (OSDP_POLL).

OSDP_RAW message format:

```

CMD          OSDP_RAW (fixed value 0x50)
byte 0      Reader number (fixed value 0x00)
byte 1      Format code (fixed value 0x00 = raw bit array)
byte 2/3    Bit count data length LSB first (bit count = length in bytes x 8)
byte 4/N    Message data

```

Example license plate = "HK55EVB" :

```

50 00 00 38 00 48 4B 35 35 45 56 42
|
| 48 4B 35 35 45 56 42 = "HK55EVB"
| 38 00 = Bit count 56 (56/8 = 7 bytes)

```

5.5 Relay outputs

Use the OSDP_OUT command to control the relay outputs.

Output #0 = Relay 1.

Output #1 = Relay 2.

See chapter 4.5 for a description of the digital IO connections.

5.6 Digital inputs

Upon status change the ANPR LUMO will send input status report message OSDP_ISTATR.

The current input status can be requested by sending the input status report request message OSDP_ISTAT.

Input #0 = Digital input 1.

Input #1 = Digital input 2.

See chapter 4.5 for a description of the digital IO connections.

5.7 OSDP capabilities

The ANPR LUMO supports the OSDP v2 including the secure channel protocol.

The OSDP control panel (CP) can request the device capabilities using the OSDP_CAP command. The ANPR LUMO will respond with the OSDP_PDCAP device capabilities report. Below an overview of the ANPR device capabilities.

	Function code	ANPR LUMO
1	Input	2x IN (no supervision)
2	Output	2x OUT (+timed)
3	Card data format	Raw array of bits
4	LED control	No user LED
5	Buzzer control	No buzzer
6	Text output	No display
7	Time keeping	The ANPR LUMO is able to locally update the time and date.
8	Check character report	CRC
9	Communication security	Yes, encrypted AES128
10	Receive buffer size	65535 bytes

6 Configuration

6.1 Using the web server

Prior to accessing the ANPR using a Browser, make sure the PC network configuration is coherent with the IP-address of the device to access. E.g.: if the ANPR IP-address is 192.168.3.15, the PC in use should have assigned an IP-address belonging to the same class (e.g. 192.168.3.10). See also chapter 8.1.1 for details about how to assign an IP-address to the ANPR.

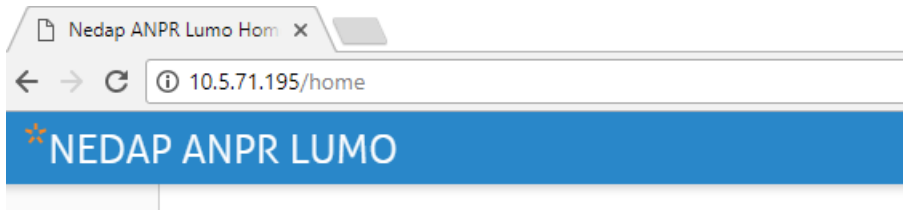

Figure 5: Using the web server

Enter the IP-address in the address bar of your web browser.
The login window appears where the user is asked to type the username and password.

Factory default username and password are:

Username: **admin**
Password: **secret**

If the login was successful, the user is now able to access the main menu screen.

Note: This document will describe all function available in ANPR LUMO version 4.8.x

6.2 Menu Items

6.2.1 Home

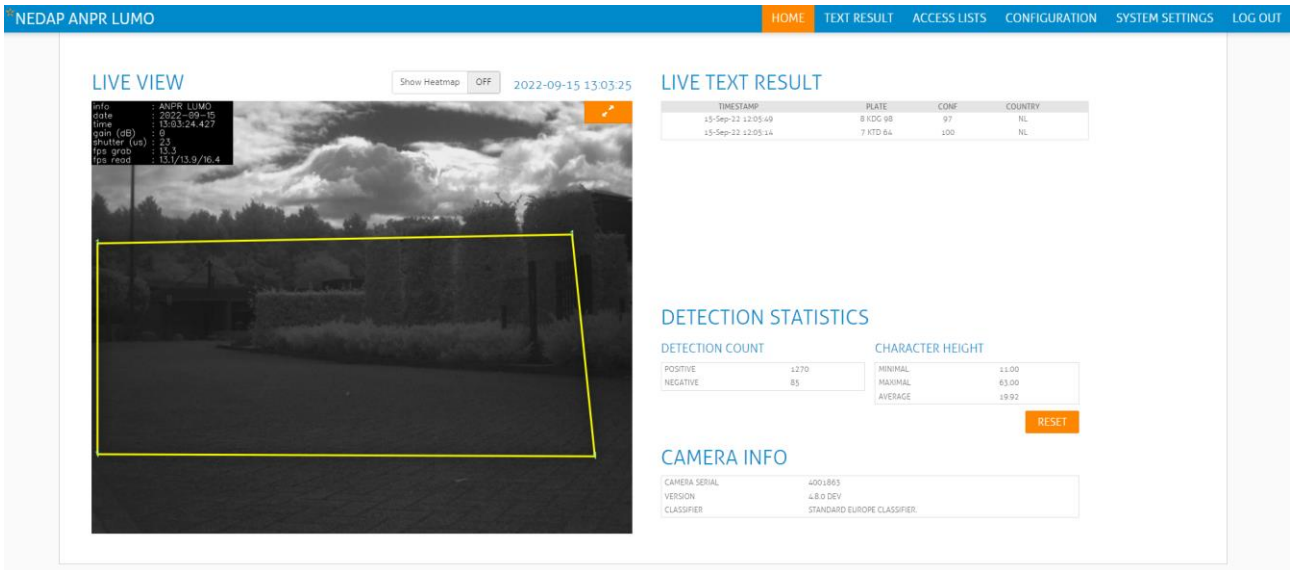

The Home screen has 4 items, the live view, the Live text results, Detection statistics and the camera information. At the camera info box, you can check which version of the software is currently installed in the camera.

The Yellow box within the LIVE VIEW represents the region of interest, this region of interest can be changed in the configuration menu, see chapter 7.2.

When the camera is being setup, it is good to know in which image regions license plates have been detected. The Heat Map button at the top of the live image turns on a visual display of all detections since the last camera restart. The current live image from the camera is colorized according to the frequency of license plates which have been detected. Color codes from dark blue (lowest frequency), orange up to red (highest frequency) are used to visualize the number of license plate detections

6.2.2 Text results

There are three different events that the results are listed for: **Accepted Results**, **Wrong Direction Results** and **NoRead Log**.

At the **ACCEPTED RESULTS** tab you can see all past results, the text results can be exported to a CSV file or excel file. The images can also be exported, when pressing the “EXPORT IMAGES” button, a zip file will be created containing the images. (depending on the amount of images, creating the zipfile can take a while)

The history is limited to the settings made at “HISTORY HOURS” and “HISTORY LIST LENGTH”.

Below the image of the actual read you can find more detailed information. The details are in which area the plate is matched, if the plate was on one of the access lists, and what action where performed.

WRONG DIRECTION RESULTS tab lists all the plates that were detected, but were outside of the designated area and moving in the wrong direction.

NoRead Log tab logs all the NoRead events, records will be added when the camera is triggered and there is no plate found in the image. Or when the camera is in the non-triggered mode, and the Noread action is defined.

Note

By default the historical length and hours is set to zero.
When changing these values follow the local privacy regulations

6.3 Access list

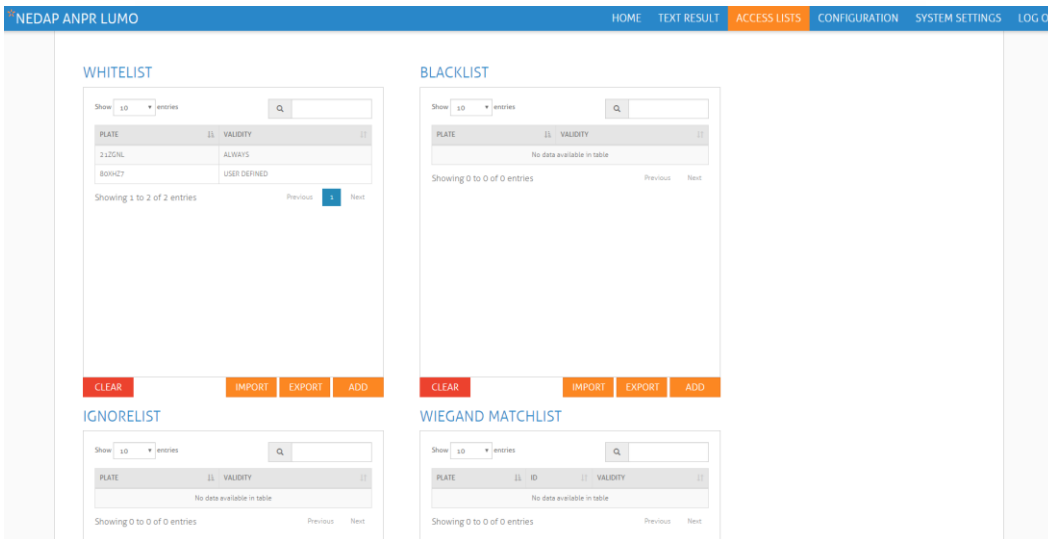

The ANPR LUMO has three “Access” lists, and one Wiegand Matchlist. The “access” lists can be used to trigger an action like activating a relay. These actions can be defined in the menu “configuration” -> “Actions” see chapter 7.3.

There are two ways to add plates to a list, you can either import a list, or manually add a plate to the list.

In the image below the license plate “80XHZ7” is always enabled, meaning that this plate is valid on this list forever.

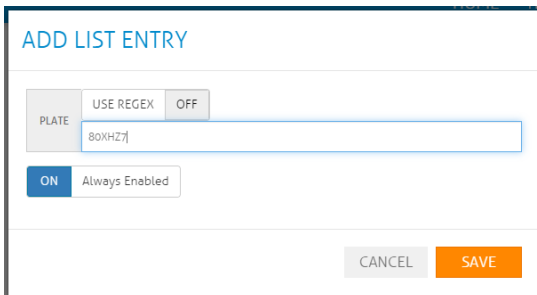

In the example below, the plate is only valid on Monday, Tuesday, Wednesday, Thursday and Friday, in the period from 12-9-2022 until 9-12-2022 from 07:00 until 18:00

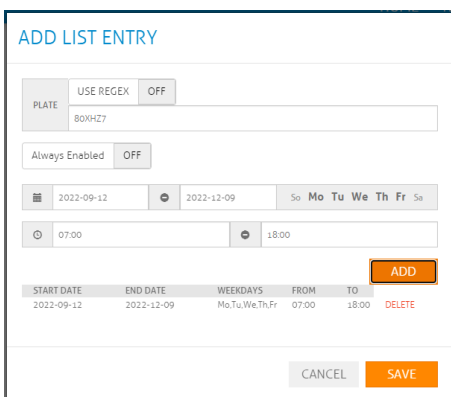

When you want to upload a file through the “IMPORT” button, follow these directives:

Open any text editor to create a file and save it any_name.txt. Only textual documents can be imported.

Enter the information according to the formatting rules and save the file. On the ACCESS configuration page click on ,Import' and select the newly created document from your device.

If importing was successful the content from the document will display on the screen. This list can here be edited if needed.

Note

A regular expression beginning with a * is invalid, because the * operator does not proceed any other atom! Use .* instead!

Formatting rules:

- Do not use blank spaces, everything should be written in a single line.
- Plate number, date and time must be separated with semicolons (;).
- When listing multiple dates/times separate them with a comma (,).
- Date format is: YYYYMMDD-YYYYMMDD, with no space between the numbers.
- Time format is: HH:MM-HH:MM. Time is always defined in combination with a date and a symbol (0/1) for the referred day of the week.
- Days of the week are represented with zeros and ones (0-not active, 1-active) written inside brackets starting with Sunday, ending with Saturday (0111110). In example "0111110" non-active days are Sunday and Saturday, represented with zeros (0).
- The amount of dates set must be equal to the amount of time restrictions (W223344;20170101-20170101,20170102-20170102,20170103-20170103;03:00-04:00(0111110),03:00-04:00(0111110),03:00-04:00(0111110)). If there are more dates than time restrictions (and vice versa) the command will be perceived as invalid.

	Example	Description
Only plate number	W223344	Always enabled
Plate number and date	W223344;20190125-20190226	Valid from 25 January 2019 until 26 February 2019
Plate number, date and time	W223344;20190125-20190225;03:00-17:00(0111110)	Valid from 25 January 2019 until 26 February 2019, between 03:00 and 17:00 on every day of the week except Saturday and Sunday (0111110)

Regular Expressions

Regular expressions are used to conveniently define patterns for license plates or groups of license plate strings.

The ANPR LUMO uses a powerful set of regular expressions, of which the most important details are described in the following paragraphs.

In the ANPR LUMO regular expressions, all characters match themselves (example: A is always A, B matches B etc.) except for some special characters:

. [] {} * + ?

The single character '.' when used outside of a character set (see below) will match any single character. E.g. the regular expression G.23456 will match G123456, or GU23456

(In the above expression, the "." is matched by 1 or U respectively)

A character range is defined by a list of characters enclosed in []. For example [A-D] will match any single character in the range 'A' to 'D'. This character range may also be defined as [ABCD].

An atom is defined as being a character or character range.

A single atom can be repeated with the *, +, ?, and {} operators.

The * operator will match the preceding atom zero or more times, for example the expression A*B will match any of the following: B AB AAAAAAAAAAB or the expression A[BC]*D will match AD ABCD ACCCBBD

The + operator will match the preceding atom one or more times, for example the expression A+B will match any of the following: AB AAAAAAAAAAB But will not match: B

The ? operator will match the preceding atom zero or one time, for example the expression CA?B will match any of the following: CB CAB But will not match: CAAB

An atom can also be repeated with a bounded repeat, where the number of allowed repeats is defined as part of the regular expression:

A{n} Matches 'A' repeated exactly n times.

A{n,} Matches 'A' repeated n or more times.

A{n, m} Matches 'A' repeated between n and m times inclusive.

For example:

A{2,3}

Will match either of: AA AAA But neither of: A AAAA

The following paragraphs give some examples for regular expressions and use cases:

To match any license plate strings of at least length 1:

.+

Match license plate strings which consist of digits only:

[0-9]+

Match all taxis, under the assumption that taxis have a license plate string that ends with TX:

.+TX

Match all license plates that start with a letter and end with a digit:

[A-Z]+.[0-9]+

Match all license plates from the Nedap company, assuming that their license plates consist of a NEDAP string and a following 3 number digit (like NEDAP001):

NEDAP[0-9]{3}

When making a list using regular expressions, the string should always start with "!" sign.

6.3.1 Wiegand matchlist

The Wiegand matchlist makes it possible to match a license plate with a pre-defined Wiegand ID.

In the example below the license plate “21ZGNL” is matched with Wiegand ID 12, the license plate 30XHZ2 is matched with Wiegand ID 17.

A number plate which is not on the list, will be send as 1112

WIEGAND MATCHLIST

Show 10 entries

PLATE	ID	VALIDITY
21ZGNL	12	ALWAYS
30XHZ2	17	ALWAYS

Showing 1 to 2 of 2 entries Previous **1** Next

NO MATCH ID	1112	SAVE
NO PLATE ID	1113	SAVE

CLEAR **IMPORT** **EXPORT** **ADD**

The Wiegand output format must be defined in the ACTIONS menu. See chapter 7.3.

7 Configuration menus

7.1 CAMERA

After installation camera configuration should take place. The essential segment of ANPR is image acquisition. Quality of images depends on the camera and illumination preferences.

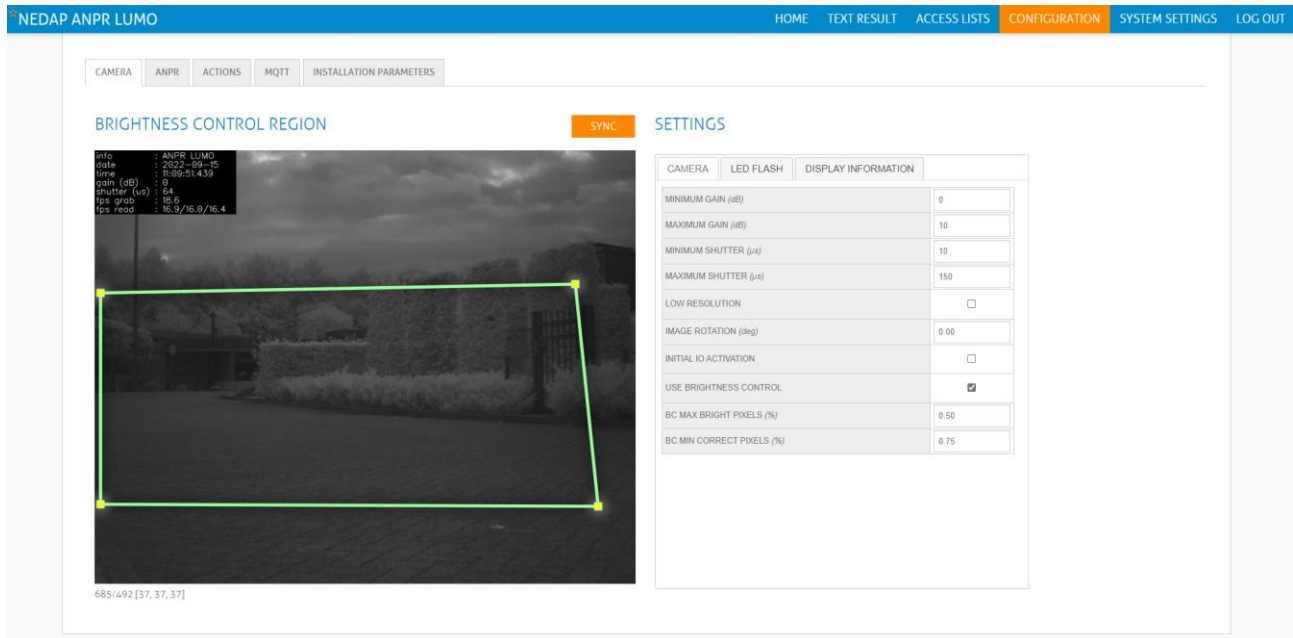

The area within the green polygon is the brightness control region of interest (ROI). It defines the image area within which the camera measures and corrects the image brightness. With the “SYNC” button you can synchronize the Region of interest settings from the ANPR menu.

It is important to minimize this surface and limit it to the area only where plates are expected to appear. This maximizes the impacted of brightness control parameters during image acquisition, on the selected area. Any change will be stored directly!

Explanation CAMERA SETTINGS:

MINIMUM GAIN (DB):

Gain controls the amplification of the signal from the cameras sensor. It boosts the signal by some amount thereby making already captured images look brighter. As a result of signal enhancement negative image blur may occur. Default 0

MAXIMUM GAIN (DB):

Gain controls the amplification of the signal from the cameras sensor. It boosts the signal by some amount thereby making already captured images look brighter. As a result of signal enhancement negative image blur may occur. The reason is that the overall signal is boosted, making also noise more visible.

Reasonable upper limits are typically 6-10 db. We recommend a maximum gain value of 10 for the Camera. Default 10

MINIMUM SHUTTER (µs):

Minimum shutter refers to minimal exposure time in microseconds that the shutter will stay open. Default 1

Shutter speed should be changed according to vehicle speed. If the vehicle is approaching in high speed, the exposure time should be reduced.

When minimum shutter is set too high (in relation to the vehicle speed) it may cause lower reading performance because images can turn out blurry.

As a general recommendation, the following exposure (shutter) times are advised:

- shutter time of 50-3000 μ s on highways, for high speed vehicles
- shutter time of 50-5000 μ s in urban areas, for medium speed vehicles
- shutter time of 100-10000 μ s in parking situations, for slow vehicles

MAXIMUM SHUTTER (μ s):

Maximum shutter refers to maximal exposure time (in microseconds) that the shutter will stay open. Default 150

LOW RESOLUTION:*

Camera sensor can operate in two resolutions, low resolution 640x480 pixels and high resolution, 1280x960 pixels.

If Low resolution is enabled images will be captured in 640x480 pixel resolution. If it is disabled high resolution will be activated.

IMAGE ROTATION (deg):

In situations where the camera has an oblique view onto the street, it might be preferable to rotate the camera image after capture so that the license plates appear horizontal. This is not a strict requirement for good readings, but it can improve recognition quality. Enter a rotation angle here in order to optimize the image alignment. The effect of the rotation parameter is directly visible after you set a new value.

INITIAL IO ACTIVATION:

By enabling this option, you activate the IO output pins as soon as the server starts. Our recommendation is to leave this option disabled at all times.

USE BRIGHTNESS CONTROL:*

allows brightness control over the defined region of interest (ROI)

BC MAX BRIGHT PIXELS (%):*

Exposure control of the camera counts all good pixels within the Brightness control ROI. Good pixels are those, which are not too dark or too overexposed. Default 1,00

BC MIN BRIGHT PIXELS (%):*

All pixels with lower brightness than set in Brightness control brightness low will be considered as not enough illuminated pixels. All pixels with higher brightness value than set in Brightness control brightness high are considered overexposed. Pixels that are between low and high brightness levels are considered well lighted/correct pixels. Default 1,00

Note: items marked with a * are advanced features, and not available in the “user” role.

Explanation LED FLASH:

ENABLED FLASH:

Turn on/off the embedded IR LEDs

FLASH BRIGHTNESS:

Defines the brightness of the IR flash

Explanation DISPLAY INFORMATION:

The set of parameters in the Display Information menu allows you to configure the display of information in Live View with the On-Screen-Display (OSD).

Enabling/disabling any of these options will take immediate effect on the live image display.

OSD SIZE:*

The size of the OSD in the image

OSD POSITION:*

Position of the OSD in the image

TEXT INFO:

Text prefix is an optional identification name of the camera appointed by the user

OSD DISPLAY OPTIONS:

Several options are available from this pull down menu. Click the dialog field to open the menu.

- DRAW PLATE:** When enabled, ANPR will generate an image of the read plate and overlay it on the processed images
- PLATE VISUALISATION OPTIONS:** Select the information that needs to be added the overlay image
 - confidence (Reading confidence for the plate)
 - State (Detected country resp. state)
 - Character info (Confidence of each character)
 - Region
- LIVE VIEW JPEG COMPRESSION:*** JPEG compression reduces the bandwidth during transmission of live images in the web interface.

7.2 ANPR

These parameters represent the operating software of the camera which takes care of reading and processing requests from the received images

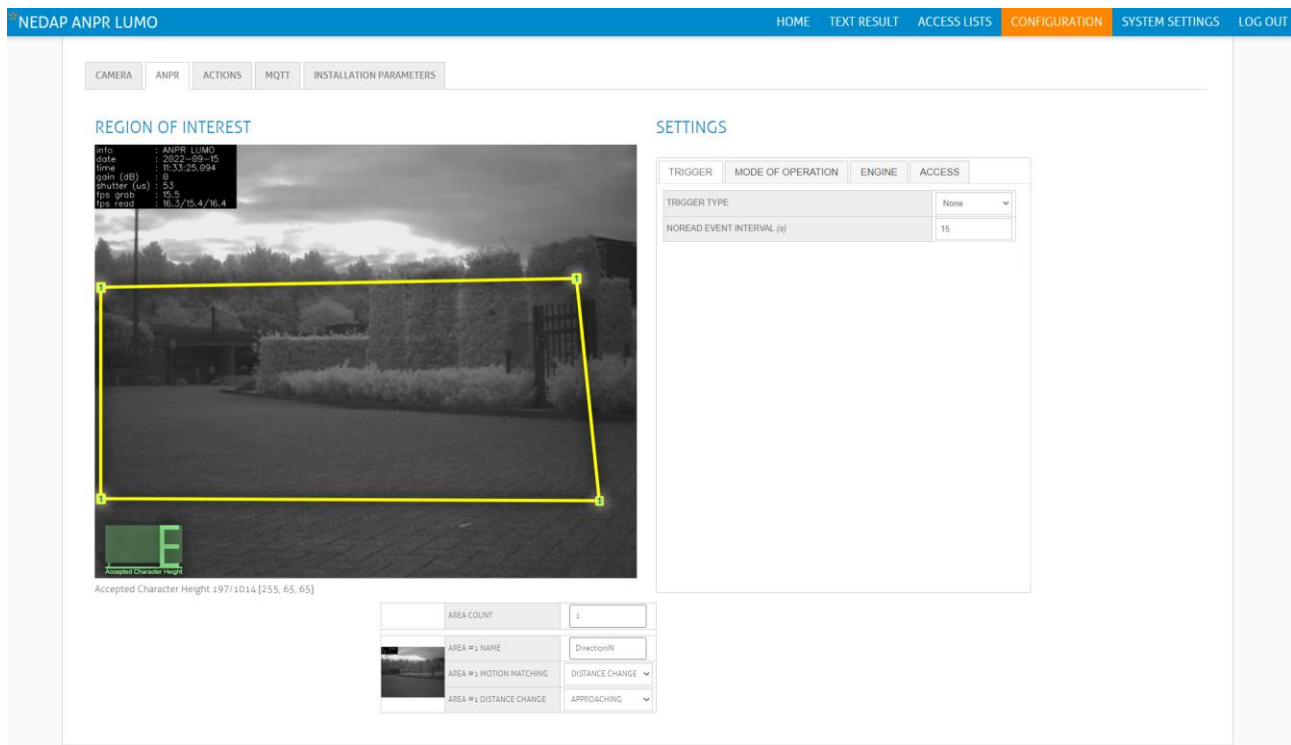

On the ANPR settings tab parameters for the following features can be altered

- TRIGGER
- MODE OF OPERATION
- ENGINE
- ACCESS

The ANPR Region of Interest (ROI) is the yellow polygon superimposed on the camera image, it defines the image region where the actual reading takes place.

In addition to the image location, the detection area may also specify a **direction and direction range of motion** or a **distance change** qualifier.

A ROI polygon can have an arbitrary number of contour points, but it must contain at least 3 points. The corners of the polygon are marked as small yellow circles with the area number inscribed (see screenshot above). The shape of the polygon can be modified as follows:

- **Reshape** the ROI by selecting one of the polygon points and dragging it to the desired location.
- **Add** more points by double clicking on an existing point, this will create a new point. You can then drag the point to a new image location.
- **Remove** a polygon point by right clicking on it.

Additionally, more than one **region of interest** can be defined by writing the number of desired regions in the Area Count field.

More than one region of interest can be defined by setting the number of desired regions in the Number of Areas box. You can also provide a custom name for an area which can be used in Actions as reference to this ROI.

The example below shows a definition of two ROIs. Note that the small images are actual live images from the camera. The areas have been given the names Entry Lane, and Exit Lane respectively.

	AREA COUNT	<input type="text" value="2"/>
	AREA #1 NAME	<input type="text" value="Entry Lane"/>
	AREA #1 MOTION MATCHING	DISABLED <input type="button" value="v"/>
	AREA #2 NAME	<input type="text" value="Exit Lane"/>
	AREA #2 MOTION MATCHING	DISABLED <input type="button" value="v"/>

ANPR Region Of Interest with Direction

An region of interest may be combined with a motion filter so that license plates are only accepted if they move in certain directions.

You can choose the type of motion filter with the pull down dialog next to Motion Matching:

Disabled

No motion filtering is used. Any license plate within the area is accepted.

Direction Angle

A license plate must move in a defined direction in order to be accepted.

Directions are visualized as green/red sectors - green sections mark the accepted driving direction, red sections define invalid directions.

In the example below, a direction from top left to bottom right of the image with an angle range of approx. 90 degrees is defined.

	AREA COUNT	<input type="text" value="1"/>
	AREA #1 NAME	<input type="text" value="Entry Lane"/>
	AREA #1 MOTION MATCHING	DIRECTION ANGLE <input type="button" value="v"/>
	AREA #1 DIRECTION ANGLE	<input type="range"/>
	AREA #1 DIRECTION RANGE	<input type="range"/>

Distance Change

A license plate must either approach the camera, or leave the camera in order to be accepted. The direction estimation is based on the size change of the license plate between readings.

Note : Distance Change would fit most situation, use Direction Angle for more complex situations

7.2.1 TRIGGER MODES

The ANPR Lumo may not only operate in free running mode, it can also be triggered by external signals. These trigger signals can enable and disable the operation of the camera in a flexible way.

Within a trigger period, when the camera is active, it behaves like in free running mode. This means that reading and sending of LP texts, list matching etc. is performed as usual.

If no LP has been detected at the end of an active trigger period, the camera can also create a NoRead event and perform an action. This feature may be useful if you are expecting a vehicle within the trigger period, but it fails to show up.

TRIGGER TYPE NONE:

TRIGGER TYPE	None
NOREAD EVENT INTERVAL (s)	15

This is the default freerunning mode, no external or internal trigger is active.

The optional NoRead parameter allows you to trigger NoRead events in regular intervals, it specifies the time span without any plate readings before a NoRead event is triggered.

By using this parameter you can set up the camera to trigger an action if no license plate has been detected.

The NoRead event mechanism can be used in all modes of operation (parking, single, etc.). For example, if parking mode is used, the camera will send the first reading of LP to a server. As long as the same car is detected, no further readings will be sent, nor will a NoRead be triggered. When the car leaves the gate, after NoRead event seconds, an action will be triggered if no other car enters the field of view of the camera.

If the NoRead interval is set to 0, it will be ignored.

trigger type IO Start/Stop:

Start and stop reading is controlled by separate Digital Inputs

TRIGGER TYPE	IO
IO TRIGGER MODE	Start-Stop
START TRIGGER LINE	In #1
START TRIGGER POLARITY HIGH	<input checked="" type="checkbox"/>
STOP TRIGGER LINE	In #2
STOP TRIGGER POLARITY HIGH	<input checked="" type="checkbox"/>

Setup: Define Start trigger Input, Start trigger polarity. In addition, define Stop trigger input and Stop trigger polarity. If Start trigger polarity high is enabled, the session will start when the input signal is transitioning from low to high. If Start trigger polarity high is disabled, the session will start when the input signal is transitioning from high to low.

Start: The session will start when the signal from Start trigger line is received.

Stop: The session stops when the signal from Stop trigger line is received. In case a new trigger signal is received while the old session is still open, the camera closes the old session and opens a new session immediately.

trigger type IO Start with timeout:

Reads numberplates until the timeout has been reached, any result is processed immediately.

TRIGGER TYPE	IO
IO TRIGGER MODE	Start-Time
START TRIGGER LINE	In #1
START TRIGGER POLARITY HIGH	<input checked="" type="checkbox"/>
TRIGGER TIMEOUT (ms)	5000

Setup: Define Start trigger input, Start trigger polarity. and Trigger timeout (ms). If Start trigger polarity high is enabled, the session will start when the input signal is transitioning from low to high. After the trigger the camera will process license plates, any result is transmitted immediately. The camera will process until the configured timeout value

Start trigger polarity high is disabled, the session will start when the input signal is transitioning from high to low.

Start: The session will start when the signal is received.

Stop: The session lasts for a defined time period as set in Trigger timeout. After the time passes the session is closed. In case a new trigger signal is received while the old session is still open, the old session will be extended to a new timeout period.

NOTE: in this case, the camera does NOT generate NoRead events for the interrupted session.

trigger type IO single Line:

Reading is triggered by a digital Input. Reading is performed as long as the line is active!

TRIGGER TYPE	IO
IO TRIGGER MODE	Single Line
START TRIGGER LINE	In #1
START TRIGGER POLARITY HIGH	<input checked="" type="checkbox"/>

Setup: Define Start trigger line, Start trigger polarity. If Start trigger polarity high is enabled, the session will start when the input signal is transitioning from low to high. If Start trigger polarity high is disabled, the session will start when the input signal is transitioning from high to low.

Start: The session will start when the signal from Start trigger line is received.

Stop: The session is ended when the signal on the input line changes its state again.

trigger type IO single shot:

This mode should only be used if the engine is set to single mode!

TRIGGER TYPE	IO
IO TRIGGER MODE	Single Shot
START TRIGGER LINE	In #1
START TRIGGER POLARITY HIGH	<input checked="" type="checkbox"/>

Setup: Define Start trigger line, Start trigger polarity. If Start trigger polarity high is enabled, the session will start when the input signal is transitioning from low to high. If Start trigger polarity high is disabled, the session will start when the input signal is transitioning from high to low.

Start: The session will start simultaneously with the activation of the camera.

Stop: The session ends after grabbing one shot.

Trigger type TCP Start/Stop:

This trigger type allows SW triggering. Send a TCP message from your server to the camera IP address and the specified port as follows:

- The messages all have exactly length 1.
- A message with value 1 (0x01) is interpreted as Start signal.
- A message with value 0 (0x00) is interpreted as Stop signal.
- All other messages will be ignored.

TRIGGER TYPE	TCP
TCP TRIGGER MODE	Start-Stop
TCP TRIGGER PORT	5005

Setup: TCP Trigger Port.

TCP Trigger Port - set a port used for the TCP Trigger.

Start: when a messages with value 1 (0x01) Byte is received.

Stop: when a messages with value 0 (0x00) Byte is received.

Trigger type TCP Start with timeout:

Reads numberplates until the timeout has been reached, any result is processed immediately.

TRIGGER TYPE	TCP
TCP TRIGGER MODE	Start-Time
TCP TRIGGER PORT	5005
TRIGGER TIMEOUT (ms)	5000

Setup: TCP Trigger Port, Trigger Timeout (ms)

TCP Trigger Port - set a port used for the TCP Trigger. *Trigger timeout (ms)* - maximal waiting time in milliseconds for an ANPR reading after a trigger signal.

Start: when a messages with value 1 (0x01) Byte is received.

Stop: when the time defined in *Trigger timeout (ms)* ends.

Trigger type TCP Single shot:

This mode should only be used if the engine is set to single mode.

TRIGGER TYPE	TCP
TCP TRIGGER MODE	Single Shot
TCP TRIGGER PORT	5005

Setup: TCP Trigger Port

TCP Trigger Port - set a port used for the TCP Trigger.

Start: when a message with value 1 (0x01) Byte is received.

Stop: The session ends after grabbing one shot.

Trigger type HTTP Start/Stop:

Control the reading with HTTP requests to endpoints

TRIGGER TYPE	HTTP
HTTP TRIGGER MODE	Start-Stop

Setup: no need for setups

Start: when an HTTP GET Request gets to the endpoint:

http://camera_ip/trigger/start

Stop: when an HTTP GET Request gets to the endpoint:

http://camera_ip/trigger/stop

Trigger type HTTP Start with timeout:

Reads numberplates until the timeout has been reached, any result is processed immediately.

TRIGGER TYPE	HTTP
HTTP TRIGGER MODE	Start-Time
TRIGGER TIMEOUT (ms)	5000

Setup: Trigger Timeout (ms)

Trigger timeout (ms) - maximal waiting time in milliseconds for an ANPR reading after a trigger signal.

Start: when an HTTP GET Request gets to the endpoint:

http://camera_ip/trigger/start

Stop: when the time defined in *Trigger timeout (ms)* ends.

Trigger type HTTP single shot:

This mode should only be used if the engine is set to single mode.

TRIGGER TYPE	HTTP
HTTP TRIGGER MODE	Single Shot

Setup: no need for setups

Start: The session will start simultaneously with the activation of the camera.

Stop: The session ends after grabbing one shot.

7.2.2 MODE OF OPERATION

Depending on the application of the ANPR Lumo, different methods for image acquisition and internal data processing might be needed.

The configuration settings in this menu affect the way the camera handles image sequences, duplicate readings, and reading errors.

The Mode of Operation is mainly defined by the Streaming Mode - the method and way images are buffered in the device memory. For example, more buffering will increase the latency of the reading (the time until you get a reading result), but it allows the camera to examine more readings and correct errors.

The dialog in this menu offers you good starting points for parameter sets which are useful for the intended application scenarios, but they can be adjusted to your needs.

SINGLE MODE:

STREAM MODE	Single
SEND UTF-8	<input checked="" type="checkbox"/>

Returns every single license plate reading without combining multiple identical readings.

The camera reads every single image as quickly as possible. Each input image is considered on its own and unrelated to images before and after it..

PARKING MODE:

STREAM MODE	Parking
MINIMUM DETECTIONS	3
MAXIMUM CHARACTERS MISMATCH	1
SEND UTF-8	<input checked="" type="checkbox"/>
DROP AFTER (ms)	1000
RESET AFTER (s)	0

Returns only unique license plates, multiple readings are suppressed.

This mode is designed for access and parking control uses. Each vehicle number plate is required to be detected at least the number of times defined in **Minimum Detections**. When this value has been reached, the LP will be available as reading and from here on be suppressed.

The **Minimum Detections** parameter controls how many readings of the same license plate have to be made until a definite result is accepted by the camera.

Maximum characters mismatch refers to the maximum number of characters by which two consecutive readings are allowed to differ and still be considered identical. The useful range for this parameter is 0-3.

A new reading is accepted as valid if:

- The number of character differences to previously read strings is not greater than Maximum character Mismatch.
- If it is detected inside the ANPR region of interest.

You can reset the suppression of identical readings with the setting in **Reset After (s)** to retransmit a LP after some time. If Reset After (s) is set to 0, plates will never be retransmitted.

OFFLINE MODE:

STREAM MODE	Offline ▾
MINIMUM DETECTIONS	3
MAXIMUM CHARACTERS MISMATCH	1
SEND UTF-8	<input checked="" type="checkbox"/>
DROP AFTER (ms)	1000
RESET AFTER (s)	0

The main purpose of this mode is to detect LP with the best possible quality. In this mode the results are available with a delay of about 2 seconds.

FREEFLOW MODE:

STREAM MODE	Freeflow ▾
MINIMUM DETECTIONS	2
MAXIMUM CHARACTERS MISMATCH	1
SEND UTF-8	<input checked="" type="checkbox"/>
DROP AFTER (ms)	1000
RESET AFTER (s)	0

This mode is designed for freeflow operation. Still considering the **Minimum Detections** parameter, the camera tries to read as quickly as possible without generating too much latency. Results may become available with a delay of up to 1.5 seconds.

The difference to Parking Mode is a larger internal Buffer Size, which increases reading quality at the cost of a higher delay of results.

7.2.3 ENGINE

The preset default values of the Lumo engine usually result in good reading results, but they can be modified to tune the OCR to specific application demands. The Engine page allows you to adjust all parameters necessary to optimize the reading of license plates with the ANPR Lumo engine.

READING MODE	Standard ▼
MIN LETTER HEIGHT (px)	11
MAX LETTER HEIGHT (px)	100
MAX PLATE ANGLE (deg)	20
MIN PLATE CONFIDENCE (%)	40
LIMIT OF LOW CONF (%)	55
MAXIMUM PLATES	2
MINIMUM CONTRAST	50
SCALE WIDTH (%)	100
SCALE HEIGHT (%)	100
SEARCH INVERTED	Disabled ▼
ENHANCED DETECTION	<input type="checkbox"/>
ADVANCED STATE DETECTION	<input checked="" type="checkbox"/>

Reading Mode

The ANPR Lumo engine can operate in several performance modes, which balance processing speed and reading accuracy differently. The faster modes offer a higher reading speed on the camera at the cost of lower reading accuracy and vice versa.

The ANPR Lumo camera offers the following reading modes:

Fastest: Fastest possible processing speed with lower recognition quality than in other modes. Recommended for open traffic where recognition speed has absolute priority.

Fast: High processing speed with slightly better recognition quality than in the fastest mode.

Standard: A good compromise between speed and reading performance, recommended to be used in most situations.

High: High mode is about half the speed compared to fast mode. The reading accuracy of the high mode is very good at reasonable speed.

Best: The best possible reading quality. It can be up to three times slower than in the fast mode. At the same time the reading confidence will be about 3-4% better than in Fast mode.

Min Letter height (px)

Defines the minimal height of characters, in pixels, that are to be recognized. The camera will only accept characters equal or larger in height than this value.

Use this parameter if license plates above a minimum size should be read- e.g. by enforcing a value of 16 px, license plates too far from the camera will be ignored because they are too small.

We recommend that this value should not be less than 12 pixels.

Max Letter height (px)

Defines the maximum height of characters, in pixels, that are to be recognized. The camera will only accept characters equal or smaller in height than this value.

Max Plate Angle (deg)

Should be used if there is a chance that the vehicles can appear rotated relative to the camera. This parameter allows to adjust the maximum rotation under which LP are still accepted.

The best results are achieved when Max plate angle is between 5° and 20°.

Try to avoid rotated LPs by leveling out the camera during installation.

Min Plate confidence (%)

Minimum plate confidence refers to the minimum confidence level at which the camera will still accept readings as valid. All readings with a lower confidence result will be ignored.

A typical value for Min Plate Confidence is 65 %. A higher value can assure that only good readings will be accepted, but there is also an increased chance that correct readings are discarded.

Limit of low conf (%)

This parameter is used to set a limit below which a LP reading confidence is to be considered low, but still valid. The lower confidence limit must be equal to/greater than the Min Plate Confidence.

The typical use of this parameter in conjunction with the Low Confidence Read action is to detect and store low quality (= low confidence) readings for further analysis or retraining.

Maximum plates

Refers to the maximum number of plates that can be detected in a single image. Setting it to 0 means that an unlimited number of plates can be detected.

If the ANPR Lumo detects more than Maximum Plates license plates within the ROI, it chooses the license plates with the highest confidences. E.g. if you set the parameter to 1, always the plate with the highest confidence is returned.

Minimum Contrast

This parameter defines the minimal contrast to differentiate foreground (characters) from the background (the license plate itself).

Reducing the minimum contrast may help to detect LPs in difficult lighting situations at the cost of a longer reading time.

It is recommended not to modify this parameter and use the default value provided by the camera.

Scale Width(%)/Scale Height(%)

Scaling means to resize an image in % relative to its original size, with separate scaling for width and height.

Scaling may help in situations where the camera sees license plates from the top or the side at a steep angle >40°. The LP will be distorted in this case, and to adjust for that, it is possible to re-scale the opposite image dimension to compensate for that.

Note that scaling will decrease the reading frame rate of the device.

Search inverted

Search inverted is an option that controls the way the ANPR Lumo engine searches for LP in terms of contrast of the characters.

- | | |
|-----------------|--|
| Disabled | The camera will only search for plates with a bright background and dark characters. This is the fastest mode and recommended if only this type of LP can occur. |
| Search | The camera will only look for white-on-dark license plates if no dark-on-white license plates have been detected. This option is a reasonable compromise between speed and detection rate. It is still recommended to use it on only when necessary. |

Always The camera will always look for white-on-black plates. This option is slow and should only be used if absolutely necessary.

Enhanced Detection

This option helps to increase the detection rate of license plates. Nedap uses additional algorithms to find license plates at the cost of lower reading speed.

Advanced State Detection

For supported countries and classifiers Nedap uses additional matching techniques in order to improve state recognition. For example it can use the logos in American license plates to directly recognize a state. This feature slows down the reading frame rate, but significantly improves the quality of state recognition.

7.2.4 ACCESS

WHITESPACE MATCHING	<input type="checkbox"/>
ACTION JPEG COMPRESSION	65
CHECK ENTRY EXPIRATION	<input checked="" type="checkbox"/>

WHITESPACE MATCHING

This parameter defines whether whitespaces (' ') should be considered during list matching.

Action JPEG Compression

This option refers only to images which are sent using actions.

JPEG compression significantly reduces the size of the images - this results in faster data transfers (e.g. ftp uploads) and reduces the bandwidth consumption of the camera.

This parameter controls the level of compression of images for action results. It can be set from 1 to 100, where a lower number means a higher compression rate with a resulting lower image quality.

Our recommendation is to set the JPEG compression level to 65, as this is a good compromise between image quality and required network bandwidth. If the camera is connected to a slow network, the JPEG compression should be reduced to a value of 50 or less.

Check Entry Expiration

This maintenance feature enables a clean-up process in the camera which checks every hour for expired list entries. If a list entry is out of date it will be removed from the list.

We recommend to leave this feature on at all times.

7.3 ACTIONS

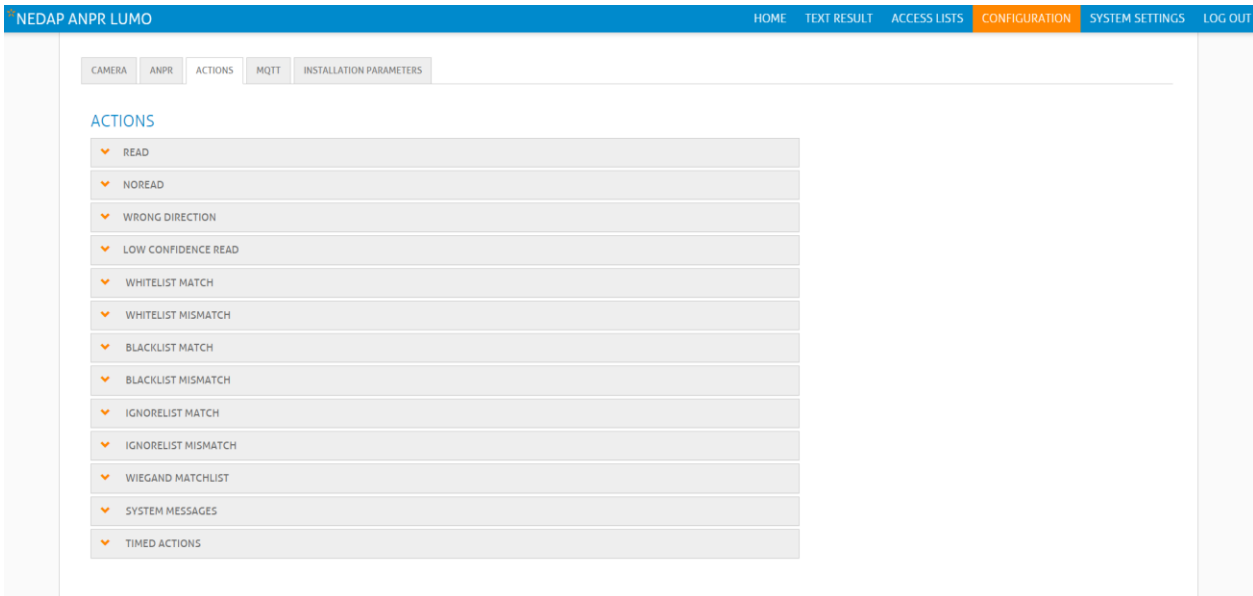

In the actions menu, you can define what actions the camera should perform on certain events.

- READ** When ANPR recognizes a plate
- NOREAD** When there are no plates recognized between given limitations set under ALPR Configuration-Trigger (i.e. Start and Stop trigger, or Start trigger and Trigger timeout).
- WRONG DIR.** Wrong Direction occur when a new license plate is detected, but it moves in a direction which is not within the allowed direction range defined for the area in which this plate is located.
- LCR** Low confidence read event is created when a plate is read but the confidence level is lower than set in parameter "LIMIT OF LOW CONF (%)"
- LIST MATCH** The action that should be performed when the plate is found on one of the Match lists.
- LIST MISMATCH** The action that should be performed when the plate is not found on one of the lists.
- TIMED ACTIONS** Are triggered by a timer in regular intervals. For example, the Lumo can send a live image every hour to a server.

The following actions can be added to any of the events, you can also make combination of actions.

Ftp Upload, Ftp Database, Store, Digital out, Serial, TCP, HTTP, HMAC_HTTP, WIEGAND26, WIEGAND64

For all actions you can define for which Area of interest the action should be performed. E.g. ALL AREAS or just one selected AREA.

Finally, before you save an action to the camera, you can test it by pressing the **TEST** button and so find invalid parameters, server names etc.

7.3.1 DIGITAL OUT

This action will produce digital output for a specific time period

- OUTPUT LINE** Which output should be activated 1=relay1, 2=relay2
- INVERT SIGNAL** If enabled the output will become active
- OUTPUT DURATION** The time in milliseconds that the output will be activated

7.3.2 FTP UPLOAD

FTP upload can save image files of detected plates to a remote FTP server.

Set to “ON” for the action to be executed.

HOST	Enter the Host ftp servers IP address or name, as ftp://
AUTHENTICATION	Select the authentication method
USER	The username of the ftp server (The user needs read/Write right)
PASSWORD	The password of the ftp server
PRIVATE KEY	Upload the private key which is to be used for authentication
NAMING PATTERN	Are used to include specific reading information (date, time, plate...) in the file name. How to use and format names using message placeholders. See appendix A.
IMAGE UPLOAD	Empty file - sends files with no images. This saves memory and increases the upload speed. Full image – the whole image taken by the camera License plate – only the license plate is send Cropped Image - An image cropped around the LP with a size in % relative to the original size and scaled to 'Final Image Width/Height' dimensions. Cropped LP Size - An image cropped around the license plate with a size in % relative to the original license plate size and scaled to 'Final Image Width/Height' dimensions.
IMAGE QUALITY	Refers to the compression rate, it can be set from 1 to 100%, 1 being the maximal compression level which will produce images with the lowest quality, and 99 being the minimal compression level with the highest image quality. We recommend to set this to 65-70%.

7.3.3 FTP DATABASE

FTP database will create and automatically update a text file on the FTP server, containing information about vehicle number plates recorded by the ANPR.

Set to “ON” for the action to be executed (as shown on the image).

HOST	Enter the Host FTP servers IP address or name, as ftp://
AUTHENTICATION	Select the authentication method
USER	The username of the ftp server (The user needs read/Write right)
PASSWORD	The password of the ftp server
PRIVATE KEY	Upload the private key which is to be used for authentication
FILENAME	Enter the name of the database to be updated (created) with newly recorded information.
ENTRY PATTERN	Defines the data to be recorded in the file. How to form entry patterns. See appendix A.

7.3.4 STORE

Store will save an image on the local storage. We would only recommend to use this option to collect images for testing purposes.

FOLDER	the path for example: /root/demo
MIN FREE SPACE	The amount of free space left on the device. If there is less space than defined here, files will not be stored anymore. (no fifo)
FILENAME	The name of the file, the filename can be composed using placeholders
IMAGE STORE	Images can be cropped and stored as with the ftp action type

7.3.5 HTTP ACTION

With the HTTP action you can send an HTTP message with a specific Request type like Post, Put etc .

REQUEST TYPE	The request type, PUT, POST, PATCH, DELETE
URL	The URL of the server where the message should be send to
AUTHENTICATION	Select BASIC or Certificate based authentication
USER	The username to login on the webserver
PASSWORD	The required password credentials
CERTIFICATE	The Certificate used for authentication
PRIVATE KEY	The private key file used
MESSAGE	The composed message for the action using the message placeholders, see appendix A.

7.3.6 HMAC HTTP ACTION

The HMAC protocol allows you to define messages for secure communication with a server in a flexible way.

You can mix fixed text elements with the typical ANPR Lumo placeholders in order to create dynamic HTTP headers and body texts.

REQUEST TYPE	The request type, PUT, POST, PATCH, DELETE
URL	The URL of the server where the message should be send to
PATTERN	The pattern allows you to specify the message body, including the Lumo placeholders
KEY	Allows you to specify the key value, which is used to encrypt the message hash
HASH	specifies the elements of the message for the computation of the message hash. You can mix text fields with Lumo placeholders
HEADER LIST	Header parameters specify, which elements are combined to make up the HTTP message header. You can add an arbitrary number of elements to the list by clicking the + button, or remove an existing entry by clicking the – button.

7.3.7 TCP ACTION

With this action you can send a message through the IP interface to a destination IP and port.

IP/HOSTNAME	The destination IP address or hostname where the message should be send to
PORT	The destination port
MESSAGE	The composed message for the action using the message placeholders, see appendix A.

7.3.8 SERIAL

With this action you can send a message through the RS485 port

BAUD RATE	The baud rate of the serial message, default 115200 (When the camera supports OSDP the baudrate is set in the System settings page)
MESSAGE	The composed message for the action using the message placeholders, see appendix A.

7.3.9 SERIAL OSDP

With this action you can send an OSDP message through the RS485 port.

OSDP communication mode must be enabled in SYSTEM SETTINGS - SERIAL SETUP. See page 42.

MESSAGE The composed message for the action using the message placeholders, see appendix A.

The ANPR LUMO will send the message data in raw bit array format (OSDP_RAW).
The data report will be sent in response to a poll command (OSDP_POLL).

7.3.10 MQTT

With this action you can publish events to an MQTT broker.

SERVER The MQTT broken that is configured in the tab MQTT
TOPIC The MQTT topic that is used within the MQTT server
QOS Set the QoS value that is required for the topics
MESSAGE The message or value that is used for the configured topic

7.3.11 WIEGAND 26

The license plate will be converted using the Wiegand 26 bit SHA-1 security hashing algorithm.

Wiegand 26-bit SHA-1 conversion procedure:

- 1) Receive license plate message hk 55 evb
- 2) Turn into upper case HK 55 EVB
- 3) Remove spaces HK55EVB
- 4) Calculate SHA-1 digest A44F633C 8A6D1581 50CCEB3E F83D9DE0 BA80CF15
- 5) Truncate. Keep least significant 24-bits A80CF15
- 6) Add parity bits according to Wiegand 26-bit format

7.3.12 WIEGAND 64

The license plate will be converted to a Wiegand 64-bit format.

In this mode, every received license plate message is converted to a Wiegand 64-bit

The first four bits are always 0110.

Next 10 groups of 6 bits. Each 6-bit group contains a license plate character. See character conversion table below.

If the license plate string contains less than 10 characters, the first groups are « empty » (= 000000).

If a character is not found in the conversion table, then the conversion uses « other » (=111111)

CHAR	6-BIT	CHAR	6-BIT	CHAR	6-BIT	CHAR	6-BIT
'0'	010000	'A'	011010	'K'	100100	'U'	101110
'1'	010001	'B'	011011	'L'	100101	'V'	101111
'2'	010010	'C'	011100	'M'	100110	'W'	110000
'3'	010011	'D'	011101	'N'	100111	'X'	110001

7.4 Installation parameters

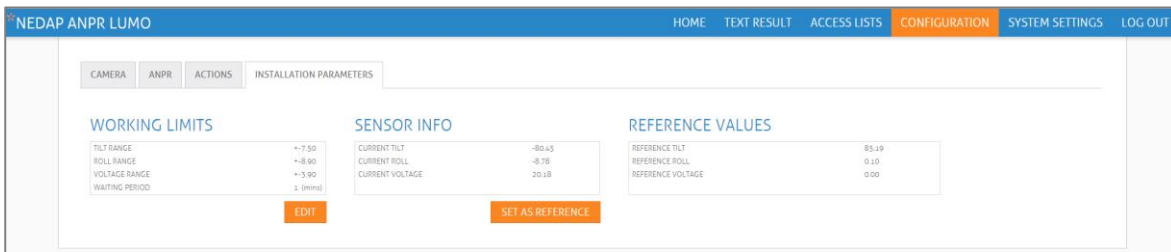

The camera has tilt, roll and voltage sensor. These sensors can be used to trigger an alarm.

First you set up the working limits, these are the limitations in which the camera may work.

By pressing the "SET AS REFERENCE" button, you tell the camera that the current values are the values that are good.

As soon as a values exceeds the limits, an alarm is raised. This can be used as an action (SYSTEM MESSAGES)

8 SYSTEM SETTINGS

In the SYSTEM SETTINGS menu you can change all system related settings like Network, Users, Classifiers and do system related actions like making backups.

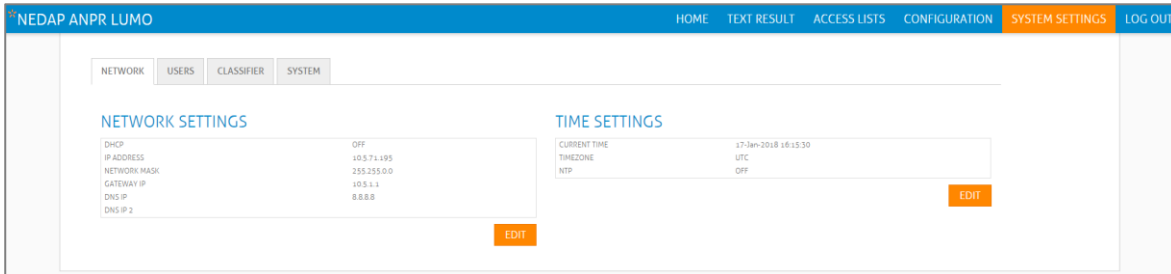

8.1 NETWORK

The NETWORK menu has two settings screens, one for the Network interface and one for the time synchronization

8.1.1 NETWORK SETTINGS

In the NETWORK SETTINGS screen you can change the network interface of the camera, you can either choose to use DHCP or setup the network settings manually.

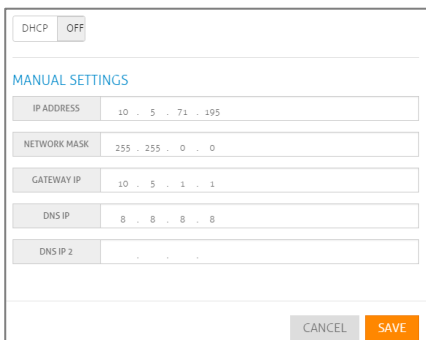

8.1.2 TIME SETTINGS

You can setup the camera to either use a NTP server for automatic time synchronization, or you can change the time manually.

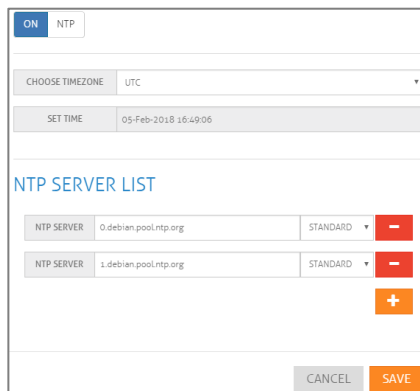
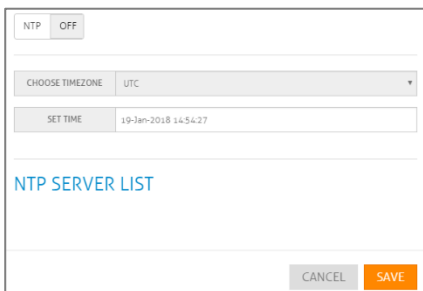

8.2 USERS

Through the USERS menu you can add/modify/remove users who have access to the web interface of the camera.

With the orange “NEW USER” button, you can create new users who will have access to the camera. By clicking on the gray box around a username, you can modify or remove the user.

The camera has four different user-roles, these roles cannot be modified.

ADMIN Users with the “ADMIN” role have full access to the camera, and have advanced features on the CAMERA/ANPR-CONFIGURATION tabs.

USER Users with the “USER” role, have basically the same rights as the “ADMIN” role, but only the basic features are presented.

OPERATOR Users with the “OPERATOR” role, can modify the access lists, and can also view the text results.

VIEWER The “VIEWER” role, can only see the HOME and TEXT RESULT screen.
This user does not have any right to modify settings.

8.3 CLASSIFIER

Through this menu Classifiers can be selected or new classifiers can be loaded.

Classifiers are files which contain state/country specific information. This information can for example be the size and font of letters and numbers, the number of rows the plate is made of, the alphabet used etc.

They will improve accuracy of plate recognition according to the country/state parameter as they support ANPR with features that make recognition easier and more reliable.

8.4 SYSTEM

Through this menu all system related items can be activated

8.4.1 SYSTEM MANAGEMENT

RESTART ANPR This will restart the camera.

REBOOT SYSTEM This will completely reboot the camera.

SHUTDOWN SYSTEM This option shuts the entire system down. The system remains shut down until a manual cold start of the camera is performed.

DOWNLOAD LOGS All log files will be downloaded, this can later be used for analytics by the Nedap support team.

SAVE CONFIGURATION Save a backup of all configuration settings.

IMPORT CONFIGURATION Restore a saved configuration from file.

Import configuration has some limitations regarding the camera firmware versions:

version 4.3.1 cannot import configurations other than 4.3.1
version 4.3.2 can import configurations of version 4.3.0 and 4.3.1.

CHANGE SYSTEM PASSWORD

Changing the system password. We recommend to change the system password.

Important note:

Make sure you store this password in a secure place. The system password cannot be recovered. In case you lose the system password, the camera must to be returned to Nedap.

CHANGE LANGUAGE

Select user interface language.

UPDATE SOFTWARE

Update the ANPR Lumo software, at the file selection select the ZIP file

SETUP SERIAL *

Setup RS485 serial parameters.

The screenshot shows a web-based configuration window titled "SETUP SERIAL". At the top, there are two tabs: "OSDP" (which is active) and "COMMUNICATION TYPE". Below the tabs are three input fields: "BAUD RATE" with the value "9600", "OSDP ADDRESS" with the value "0", and "OSDP SCBK" with the value "303132333435363738393a3b3c3d3e3f". At the bottom right of the window are two buttons: "CANCEL" and "APPLY".

Select to use BASIC or OSDP communication protocol.
Select the baud rate.

When using OSDP communication, you may also select the OSDP device address and the OSDP secure channel base key (OSDP-SCBK). The OSDP key must be exactly 16 bytes, e.g. 303132333435363738393a3b3c3d3e3f.

* requires at least ANPR LUMO hardware revision A.05 and software v4.5.1.

SETUP SSL

Configure the ANPR Lumo web-interface to use SSL. If you do not upload your own certificate, a self-signed certificate is used.

TERMINAL TOOLS

With terminal tools you can run some simple network diagnostics, like ping, Traceroute and IP.

FACTORY RESET

This option is used to reset the camera configuration back to factory settings.
All custom configuration data will be lost!

8.4.2 LIBRARY VERSION

In this menu you can see the current versions of all software parts of the camera, this information can be used for support reasons.

8.4.3 DIGITAL IO

In the menu you can see the current status of all inputs and outputs.

With the buttons “ACTIVATE” you can activate the Relay outputs. With these buttons it will be possible to test the outputs.

A Message placeholders

Placeholder	Description
%LP%	License plate value (ABC123)
%LP_WS%	License plate value including white spaces. (ABC 123)
%LP_UL%	License plate value including underscores. (ABC_123)
%LP_HASH%	License plate SHA256 hashed string as hexadecimal number
%LP_SHA1_D24A%	License plate SHA1 hashed and truncated to 24 bits, outputted in ASCII format
%LP_SHA1_D24B%	License plate SHA1 hashed and truncated to 24 bits, outputted in Binary format
%STATE%	License plate state
%STATE_ALPHA_3%	License plate state in ISO 3166-1 alpha-3 country codes
%STATE_FULL%	License plate full state name
%CONF%	Confidence value
%CONF_STATE%	State confidence value
%FULL_IMG%"	Base64 encoded image of the whole image sensor
%LP_IMG%"	Base64 encoded image of the license plate
%REL_IMG_800_600_30%	Base64 image cropped relative to the full image size and resized to 800x600
%REL_LP_800_600_300%	Base64 encoded image cropped relative to the LP image size and resized to 800x600
%NUM_ROWS%"	Number of rows of license plate
%REGION%	Region string
%REGION_CITY%	City string
%REGION_SHORT%	Region short value string
%ENDING%	Ending value string
%ENDING_SHORT%	Ending short value string
%COMMA%	Comma character (,)
%BR_ON%	Round bracket open character ' (')
%BR_OFF%	Round bracket close character ') ')
%SQ_BR_ON%	Square bracket open character ([)
%SQ_BR_OFF%	Square bracket close character (])
%CR%	Carriage return character
%LF%	Line feed character
%DIRECTION%	The motion direction of the vehicle in degrees. The direction is counted clockwise
%POS_X%	X position in image of upper left corner of license plate
%POS_Y%	Y position in image of upper left corner of license plate
%POS_W%	Width of license plate in image
%POS_H%	Height of license plate in image
%ANGLE%	Direction angle in degrees (0..360) of the license plate
%YEAR%	Year. When license plate was detected
%MONTH%	Month. When license plate was detected
%DAY%	Day. When license plate was detected
%HOUR%	Hour. When license plate was detected
%MINUTE%	Minute. When license plate was detected
%SECOND%	Second. When license plate was detected
%FRACSEC%	Fraction of seconds. When license plate was detected
%AREA_INDEXES%	Indexes of areas in which the license plate was detected.
%AREA_NAMES%	Names of areas in which the license plate was detected.

B Disposal of equipment

The products will be disposed of by the end-user and discharge Nedap for any liability or responsibility thereof.



The WEEE symbol in Europe indicates that the relevant electrical product or battery should not be disposed of as general household waste in Europe. To ensure the correct waste treatment of the product and battery, please dispose them in accordance to any applicable local laws of requirement for disposal of electrical equipment or batteries. In so doing, you will help to conserve natural resources and improve standards of environmental protection in treatment and disposal of electrical waste (Waste Electrical and Electronic Equipment Directive WEEE 2012/19/EU).

C CE - UKCA declaration

Hereby NEDAP N.V. declares that the subject equipment is in compliance with:

- For CE: Directives 2014/30/EU (electromagnetic compatibility) and 2011/65/EU (Restriction of the use of certain hazardous substances).
- For UKCA: SI 2016/1091 (Electromagnetic Compatibility Regulations 2016) and SI2012/3032 (Restriction of the Use of Certain Hazardous Substances in Electrical and Electronic Equipment Regulations 2012 (RoHS)).

The full text of the declarations of conformity is available at <https://portal.nedapidentification.com> where, if applicable, also REACH information can be found.

D Document revision

Version	Date	Comment
1.14	2022-09-21	Added UKCA declaration, PoE(+) details
1.13	2020-05-17	Added new features in version 4.6.0
1.12	2020-01-05	Added OSDP features in version 4.5.1
1.11	2020-03-19	Added new features in version 4.4.0
1.10	2019-10-10	Added new placeholder underscore
1.09	2019-09-06	Added new features in version 4.3.2
1.08	2019-05-24	Changed trigger modes, and new placeholders
1.07	2019-03-05	New placeholders added, httpput added
1.06	2019-01-34	small updates.
1.05	2019-01-09	Added Wiegand matchlist feature and regular expressions.
1.04	2018-09-23	Small updates
1.03	2018-07-03	Added product photo
1.02	2018-07-02	Added working limits
1.01	2018-05-18	Text result features
1.0	2018-04-17	Changed wiring
0.1	2018-01-12	Initial document version