

AVENAR panel

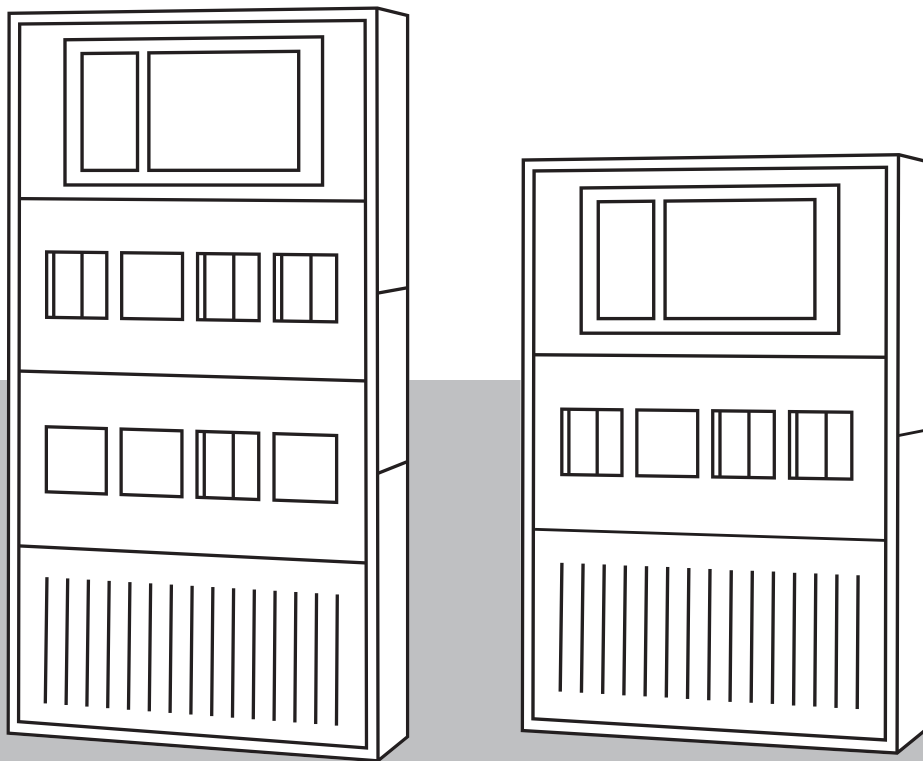

Table of contents

1	Safety	5
2	AVENAR panel series	6
2.1	Product description	6
2.2	Panel controller	10
2.3	Remote keypad	15
2.4	Housings for frame Installation	17
2.5	Housings for wall mounting	20
2.6	System overview	22
2.7	Networking	25
2.8	Connection to BIS	25
2.9	Connection to a voice alarm system	26
3	Planning	27
3.1	LSN modules	28
3.2	Detection points	28
3.3	Address setting	29
3.4	Topologies in Local Security Network	30
3.5	Failure handling in Local Security Network	32
3.6	Redundancy	33
3.6.1	AVENAR panel 8000 with panel redundancy	33
3.6.2	Remote keypad as redundant panel controller	34
3.7	Achievable cable length with LSN 0300 A	34
3.8	Achievable cable length with LSN 1500 A	36
3.9	Configuration with BCM-0000-B modules	39
3.10	Protective earth and equipotential bonding	43
4	Installation	43
4.1	General information	43
4.2	Installation sequence	45
4.3	Installation of CPH 0006 A, fully assembled panel	45
4.4	Installation of HCP 0006 A, fully assembled panel	46
4.5	Extended line monitoring (VdS 2540, VdS 2543)	47
4.6	FPP-5000 External Power Supply Unit Kit 24 V/6 A	48
5	Commissioning	49
5.1	Functional test	49
5.1.1	Testing the power supply	50
5.1.2	Testing the Conventional and LSN Functions	50
5.1.3	Testing the Addressing/Activation	51
5.2	Panel controller firmware	51
5.3	Storing trace files on a memory card	52
6	Maintenance and service	53
6.1	Replacement of FPA panel controller	54
7	System limits	56
7.1	System limits AVENAR panel 8000	56
7.2	System limits AVENAR panel 2000	58
7.3	Maximum number of devices per functional module or interface module	60
7.4	Power loss of panel components	61
7.5	FPP-5000 External Power Supply Unit Kit 24 V/6 A	62
8	Appendix	62
8.1	Options with requirements under EN 54-2:1997/A1:2006	62

8.2	Controlling Extinguishing Systems	62
8.3	Additional documentation	63
8.3.1	Frame installation housings, mounting frames and installation kits	63
8.3.2	Wall mounting housings and installation kits	64
8.3.3	Accessories for housing	64
8.3.4	Panel rails	65
8.3.5	Power supply units	65
8.3.6	Panel controller remote keypad	65
8.3.7	Functional modules	66
8.3.8	Cable sets	66
	Index	67

1 Safety

**Warning!**

Live components and stripped cable! Risk of injury from electric shock. The system must be current-free during connection work.

**Warning!**

Risk of overheating

Bosch provides no front door for this system. You are not allowed to operate the system with a front door. Otherwise, the system can overheat, because the air vents are blocked.

**Notice!**

Bosch Sicherheitssysteme GmbH uses Open Source Software. For more information see <https://www.boschsecurity.com/xc/en/oss/>.

**Notice!**

Installation must only be carried out by authorized specialist personnel.

**Caution!**

Do not use any pointed or sharp objects (e.g. screw drivers, pens, etc.) when operating the touch-sensitive display. The touchscreen may not be exposed to direct sunlight. Both can seriously damage the touchscreen.

**Caution!**

EN 62368-1: MS 3. The installation height is recommended to a maximum of 2 m.

**Notice!**

Have maintenance and inspection work carried out regularly by trained, qualified personnel. Bosch recommends a functional and visual inspection at least once a year.

**Notice!**

The fire panel is designed for indoor installation.
After installing batteries, the poles must be masked. Appropriate masking strips are included with the housing in which the batteries are installed.
Use fuses complying with national regulations to protect the power lines.

**Notice!**

Batteries must not be disposed of in household waste. Please take used batteries to the local collection points. See www.boschsecurity.com/xc/en/weee/ for further information.

**Notice!**

Consider national and local regulations when installing and operating the fire system.

2 AVENAR panel series

The fire panel is easily adapted to local requirements and regulations. Due to the different functional modules, country-specific characteristics are accommodated in the connection just as quickly as the respective alarm protocol.

With evacuation button and evacuation zone monitoring the panel achieves full safety panel functionality.

2.1 Product description

The fire panel allows mixed operation of analog addressable and conventional technology. It supports connecting periphery in either stub or loop topologies. Analog addressable fire detectors, manual call points, signaling devices, inputs and outputs are identified and managed by the fire panel as single elements. As required by the building structure the peripherals are grouped software wise in logical zones.

AVENAR panel 8000 uses functional modules that are clicked in a slot on a rail.

AVENAR panel 2000 comes as a kit in a housing. The functional modules can be plugged onto the rail inside the housing.

The rail provides power and internal communication to the functional modules. A wide range of functional modules are available providing: addressable loops, conventional zones, inputs and outputs, and interfaces to various devices.

AVENAR panel 8000 can be equipped with 46 functional modules, of which a maximum of 32 can be analog addressable loop modules. This results in a tailor-made fire panel suitable for medium to large size applications.

AVENAR panel 2000 can be equipped with six functional modules of which a maximum of four can be analog addressable loop modules. This makes the fire panel suitable for small to medium size applications.

Two different types of housings are available to assemble the fire panel:

- Wall mount housing
- Frame mount housing

The slim wall mount housings are for mounting directly to the wall. Frame mount housings require an additional frame between the housing and the wall. The frame lets space for e.g. cabling, media converters, and larger batteries. Special installation kits also allow installation in 19" racks.

The panel controller is the central component of the fire panel. A color display shows all messages. The touch screen is for operation of the entire system. The user-friendly interface adapts to various situations. This causes correct operation that is simple and clear as well as targeted and intuitive.

For AVENAR panel 8000 both housing types can be extended with up-to four housings to increase the number slots for the functional modules.

Panels and keypads of the AVENAR series and of the FPA-5000 series (MPC-xxxx-B and MPC-xxxx-C) can be combined in one panel network using the Ethernet and the CAN bus interfaces. The remote keypad is for decentralized operation of the panel or of the panel network.

Integration into large-scale systems can be done by an Ethernet interface to the Bosch Hierarchy panel (UGM) or to Building Integration System (BIS). Integration into third party management systems is possible with the availability of OPC server and Software Development Kit.

A data interface enables monitoring and full control of Bosch voice alarm systems. This makes the fire panel a complete safety solution.

The fire panel is configured on a laptop using the FSP-5000-RPS programming software. The programming software enables further adaptation, e.g. to country-specific requirements and regulations.

Features

- Completely modular fire panel, expandable up to 32 loops for AVENAR panel 8000 and up to 4 loops for AVENAR panel 2000, provides customized solutions for medium to large size applications
- High resolution display with bright colors to indicate alarms and events
- 8" touch pad with fixed and programmable buttons, thus adaptable to the situation
- Integrated Ethernet switch for networking and interfaces to remote services, building management and voice alarm systems
- Adaptable to local requirements and regulations

System overview

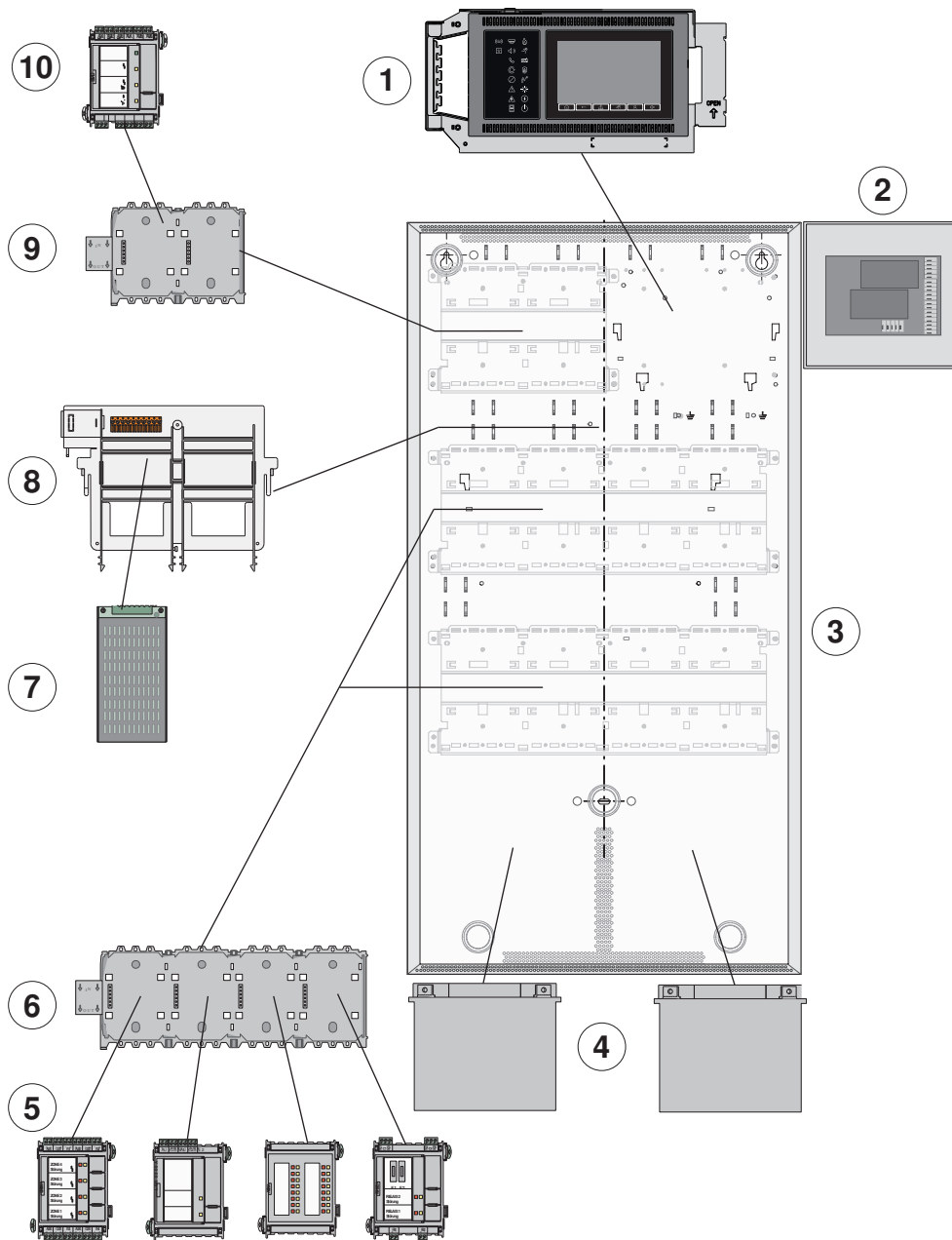

Figure 2.1: Example configuration

1	Panel controller	6	PRD 0004 A Panel Rail Long
2	Fire brigade peripheral module	7	Power supply unit
3	HBC 0010 A Panel Housing for 10 modules	8	Power supply bracket
4	Batteries	9	PRS-0002-C Panel Rail Short
5	Functional modules	10	BCM-0000-B Battery Controller Module

Functions

The panel provides complete flexibility and customized solutions for many applications.

The planning of the fire panel is supported by Safety Systems Designer for fire alarm systems. The software provides information about the size and number of housings, the modules and the energy balance calculation.

Depending on specific requirements, the planning involves choosing from the following options:

– **Housings for frame and wall mounting**

- Selection of a basic housing
- Extension housing, optional
- Power supply housing, optional
- Installation kits (optional) for installation in 482.6 mm (19") racks

– **Panel controller, premium and standard license**

The panel controller, premium and standard license, features fire detection, and connectivity with panel and remote keypad of FPA series. Each panel controller contains a hard coded software license. The licenses define the maximum panel network size and availability of certain features and interfaces. In principle, the standard license provides basic fire detection features according the standards. In addition, the premium license provides interfaces for:

- Building management system (OPC, FSM-5000-FSI)
- Hierarchy panel (UGM-2040)
- Voice alarm system (Smart Safety Link)

In addition, the following comfort feature:

- Individual control of evacuation zones and fire controls.

For more information on software licenses, refer to *Panel controller, page 10*.

For information on panel networking, refer to the Networking guide.

– **Panel rail**

- Selection according to housing type and/or number of functional modules required

– **Power supply**

- Batteries
- Power supply units for additional power supply
- Power supply brackets

The power supply brackets on frame installation housings are pre-installed ex works; for wall-mounted housings, power supply brackets can be selected as required.

– **Thermal printer**

- The thermal printer is used to document operating procedures on the panel, as well as alarm and fault messages. Plain text can also be printed. Programming is carried out via the programming software FSP-5000-RPS.

– **Additional accessories**

- Cable sets for special applications.

– **Functional modules**

Functional modules are independent encapsulated units. They are placed into a slot of a panel rail. The power supply and the data traffic with the panel are therefore provided automatically. The module is identified by the panel with no further settings and operates in the default operating mode (plug and play).

Wiring to external components is performed using compact connector/screw terminals. After a replacement, only the connectors need to be reinserted, there is no need for extensive rewiring.

Module	Description	Function
ANI 0016 A	Annunciator module	Indicating system statuses, with 16 red and 16 yellow freely programmable LEDs
BCM-0000-B	Battery controller module	Controlling the power supply to the panel and the battery charge level
CZM 0004 A	Conventional zone module	Connecting conventional peripheral devices using four monitored conventional lines
ENO 0000 B	External notification module	Connecting fire service equipment complying with DIN 14675
FPE-5000-UGM	Module interface to UGM	Connection to UGM systems
IOP 0008 A	Input-output module	Individual displays or flexible connection of various electrical devices, with 8 independent digital inputs and 8 open collector outputs
IOS 0020 A	Communication module, 20mA	With S20 and RS232 interfaces
IOS 0232 A	Communication module, RS232	Connection of two devices using two independent serial interfaces, e.g. Plena or a printer.
LSN 0300 A	LSN bus module 300mA	Connection of an LSN loop with up to 254 LSN improved elements or 127 LSN classic elements at a maximum line current of 300 mA

– **Fire brigade peripheral module**

A fire brigade peripheral module is connected via FPE-5000-UGM or via IOS 0020 A functional module. The fire brigade peripheral module FMF-ADP-TTY connects fire service devices e.g. a Fire service operating panel or a Fire brigade information center to the fire panel.



Notice!

Safety Systems Designer can be used to plan fire alarm systems that conform to the relevant limits (e.g. in terms of cable length and power supply).



Notice!

Safety Systems Designer for fire alarm systems enables the system dimensions, the energy requirements and the quantity and prices of the elements required to be estimated at each different phase in the planning process.

The software is designed for planners and engineering offices that want to produce a quotation for a fire alarm system.

2.2

Panel controller

The panel controller is the central component of the fire panel. All messages are shown on the color display. The entire system is operated via a touch screen. The user-friendly user interface adapts to various situations. This allows correct operation that is both simple and clear as well as targeted and intuitive.

The FSP-5000-RPS programming software enables adaption to project- and country-specific requirements.

Software licenses

The panel controller is delivered with a hard coded software license. This software license is implemented during production and cannot be modified, revoked or transported. The license defines the maximum panel network size and availability of certain features and interfaces. In total 4 different licenses are available.

	AVENAR panel 2000, standard license	AVENAR panel 2000, premium license	AVENAR panel 8000, standard license	AVENAR panel 8000, premium license
Ethernet interface to				
Building management system (BIS, FSM-5000-FSI)		•		•
UGM-2040 Hierarchy panel		•		•
Voice alarm system (Smart Safety Link)		•		•
Monitoring and control				
Status overview	•	•	•	•
Simultaneous control	•	•	•	•
Individual control		•		•
Modularity (maximum number)				
LSN 0300 A modules	4	4	32	32
LSN 1500 A modules	0	0	11	11
Functional modules (including LSN modules)	6	6	46	46
Panel redundancy				
Redundant panel controller			•	•
Keypad as redundant panel controller			•	•
Network				
Panel network	remote keypads	panels, remote keypads, servers	panels, remote keypads	panels, remote keypads, servers
Max. number of nodes	4 (1 panel, 3 keypads)	32	32	32

Table 2.1: AVENAR panel series, four different licenses

**Notice!**

Building Management System

A premium license is required for each panel that needs to be available in a building management system (e.g. BIS, FSM-5000-FSI). It is not sufficient to equip only one panel of the network with a premium license, if you need all panels of the network in the building management system.

**Notice!**

UGM-2040 hierarchy panel

A premium license is required for each panel that needs to be available in the UGM-2040 hierarchy panel. It is not sufficient to equip only one panel of the network with a premium license, if you need all panels of the network in the hierarchy panel.

**Notice!**

Voice alarm system connected to AVENAR panel

Each fire panel which is physically connected to a voice alarm system via Smart Safety Link needs a premium license.

**Notice!**

AVENAR panel 2000 networking

For each AVENAR panel 2000 which needs to be networked with other panels, a premium license is required. It is not sufficient to equip only one AVENAR panel 2000 with a premium license to network multiple panels. An AVENAR panel 2000 with premium license can be networked with any AVENAR panel 8000 and with FPA-5000.

**Caution!**

Do not use any pointed or sharp objects (e.g. screw drivers, pens, etc.) when operating the touch-sensitive display. The touchscreen may not be exposed to direct sunlight. Both can seriously damage the touchscreen.

**Warning!**

The power button must be used to switch off the device before removing the power supply. It may not be disconnected from power supply while system is running. The device may be damaged if this procedure is violated. Not following this procedure may result in loss of warranty. Refer to user guide for further information.

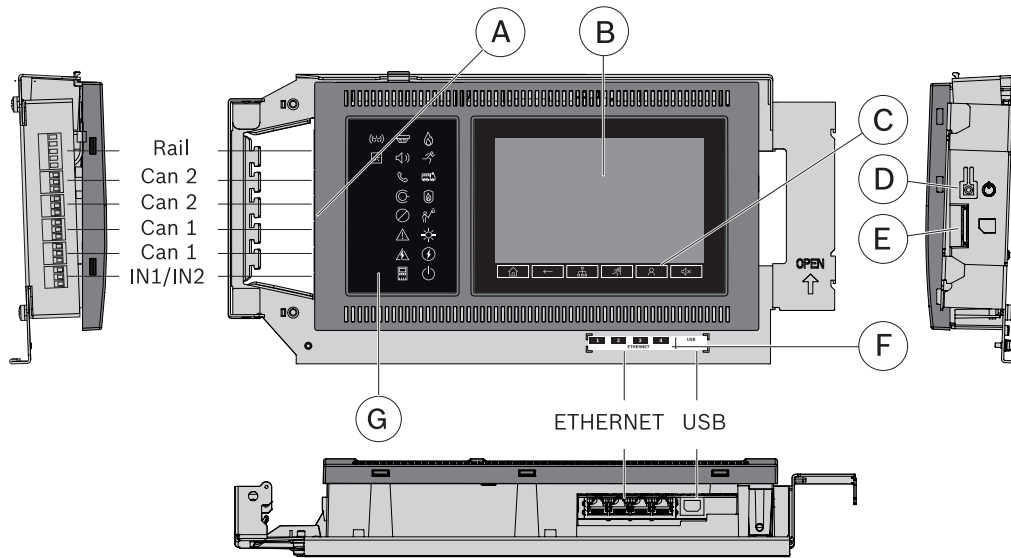

Figure 2.2: Overview of panel controller

Pos.	Designation	Function
A	Interfaces	Panel networking and inputs for internal device monitoring
B	Touchscreen	Operating the networked system through virtual buttons and variable display windows
C	6 fixed buttons	Standard entries
D	Power button	Shutdown and restart of the device
E	Memory card slot	Memory card reader for maintenance services
F	Ethernet ports	Panel networking and interface to various systems
G	18 LEDs	Indicating the operating status

Networking

A panel controller with premium license can be networked with up to 32 panel controllers, remote keypads and OPC servers.

Panels and keypads display all messages, or you can form a group of panels and keypads. Within one group, only messages of this group are displayed.

Alarm indication

All messages are shown on the display with a bright color. The displayed messages contain the following information:

- Message type
- Type of the triggering element
- Description of the exact location of the triggering element
- Logical zone and sub-address of the triggering element

At any time, the operator can request a status overview for each evacuation zone and each output connected to the fire protection equipment.

18 Icon LEDs give continuous information about the operating status of the panel or the system. A red icon LED shows an alarm. A blinking yellow icon LED shows a fault. A steady yellow icon LED shows a disabled function. A green icon LED shows proper operation. Two status LEDs, one red and one yellow, are programmable. The red one shows a self-defined alarm. The yellow one shows a self-defined fault or deactivation.

Additional annunciator modules, each with 16 red and 16 yellow LEDs are available to indicate a larger number of self-defined alarms, faults or deactivations.

Smart Safety Link

Smart Safety Link is the most reliable and secure interface to combine a fire detection and a voice alarm system (VAS). Smart Safety Link offers exceptional flexibility and options for expandability.

The bi-directional data communication establishes a supervised connection between the fire detection panel and the VAS. Both the fire panel and the VAS indicate a fault message when the connection is interrupted. In case of an interrupted connection, the user can start the evacuation of the complete building manually by using a call station of the VAS. An interruption of the interface does not lead to an automatic evacuation of the building. When the interface is re-established, the fire panel automatically re-synchronizes the current alarm state with the VAS. In case of a fire condition, the fire panel can automatically start voice announcements using virtual VAS triggers that are activated by rules which are configured in FSP-5000-RPS. The fire panel generates a supervisory message when an evacuation event is started from the VAS. A malfunction on the VAS will generate a fault message on the user interface of the fire panel.

For the connection to the PRAESENSA, the Praesideo and the PAVIRO voice alarm systems, an Ethernet interface is used. Smart Safety Link to PRAESENSA features TLS encryption which guarantees a high level of data protection. The Ethernet interface provides up to 244 freely configurable virtual VAS triggers. The Plena VAS uses an RS232 interface of the IOS 0020 A or IOS 0232 A communication module. The Plena VAS can be configured with up to 120 virtual VAS triggers.

Operator management

The system can have up to 200 different registered operators. Login is permitted with a user ID and an 8-digit pin code.

There are four different authorization levels. Depending on the authorization level it is possible for the operator to do certain functions according to EN54-2.

Languages

The operator can change the language of the user interface. A quick user guide for each language is available. Following languages are included in the package: English, German, Bulgarian, Croatian, Czech, Danish, Dutch, Estonian, French, Greek, Hungarian, Italian, Latvian, Lithuanian, Polish, Portuguese, Romanian, Russian, Serbian, Slovak, Slovenian, Spanish, Swedish and Turkish.

The quick user guides of following languages are available only online at www.boschsecurity.com: Hebrew and Ukrainian.

Operation and processing of messages

For operating the panel, an 8 inch touch pad as input medium is put upon the display. There are 6 buttons with fixed functionality as well as 3 programmable function keys.

Examples for the assignment of the function keys:

- Set the panel controller to day mode, set the panel controller to night mode
- Enable detection points or outputs, disable detection points or outputs
- Set standard sensor sensitivity, set alternative sensor sensitivity

Each function key has a virtual status indicator.

At any time, an operator with sufficient user rights can activate each evacuation zone and each output connected to fire protection equipment via the user interface.

The panel controller features

- 2 CAN interfaces (CAN1/CAN2) for networking

- 1 Rail connector
- 4 Ethernet interfaces (1 / 2 / 3 / 4) for networking, prescribed usage:
 - 1 and 2 (blue): Panel network
 - 3 (green): Building management system, hierarchy panel, voice alarm system
 - 4 (red): Remote Services
- 2 signal inputs (IN1/IN2)
- 1 USB function interface for configuration via FSP-5000-RPS
- 1 Memory card interface

Saving and printing messages

The history log keeps incoming alarms and events internally. The history log has a capacity to store 10000 messages. The messages can be shown on the display, and you can export the messages. Additionally, you can connect a log printer via a serial interface module for real-time printing incoming messages.

Installation

Refer to the Installation guide for FPE-8000-SPC | FPE-8000-PPC | FPE-2000-SPC | FPE-2000-PPC panel controller (F.01U.347.557) available for download at www.boschsecurity.com.

2.3

Remote keypad

The remote keypad can be used to perform the same operating procedures as the control panel, enabling variable operation of a networked system. It has the following functional elements:

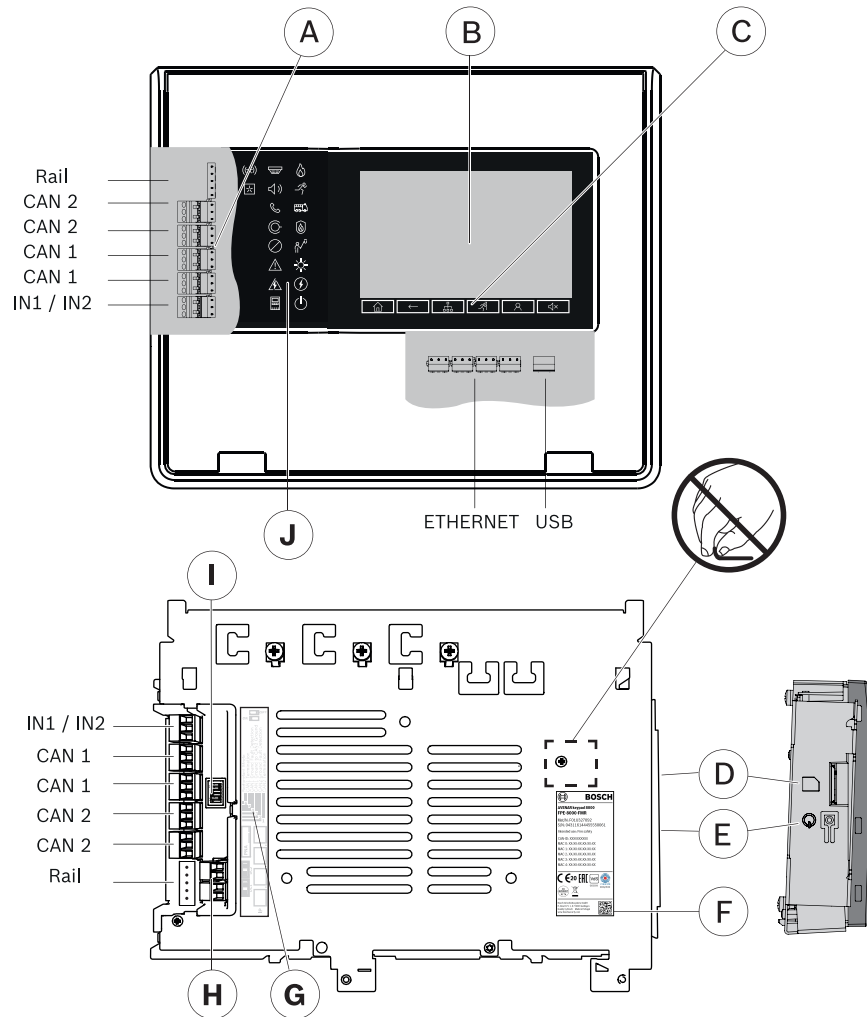

Pos.	Designation	Function
A	Interfaces	CAN1, CAN2, IN1/2, Rail
B	Touchscreen	Operating the networked system through virtual buttons and variable display windows
C	6 fixed buttons	Standard entries
D	Memory card slot	Memory card reader for maintenance services
E	Power button	Shutdown and restart of the device
F	Product label	Important product data
G	DIP switch label	DIP switch label with areas to write down the PNA (Physical Node Address) and the IP address
H	Power supply	DC1 / DC2
I	6-pin DIP switch	DIP switch settings for CAN bus networking & panel redundancy
J	18 LEDs	Indicating the operating status

It comes with easy-to-install housing for tilted installation and for surface or flush wall mounting. Power can be supplied by the panel or an external power supply unit such as the FPP-5000.

In combination with an AVENAR panel 8000, standard or premium license, an AVENAR keypad 8000 can be used as a redundant panel controller. Only in this case the rail connector is needed.

Installation

Refer to the installation guide for the FPE-8000-FMR Remote keypad (F.01U.347.558) available for download at www.boschsecurity.com.

2.4 Housings for frame Installation



Figure 2.3: Housings for frame installation

Frame installation housings are always used in conjunction with the associated mounting frame.

The housings are hooked into the mounting frame and can be swiveled to the front for installation and servicing. The mounting frames are screwed to the wall surface and hold the pre-cabling.

Alternatively to surface mounting, installation in 482.6 mm (19") racks is also possible using special installation kits.

12 V/45 Ah batteries can be used in the frame installation housing.

The modular system makes it easy to extend the system.

Housing Designs and Combinations

Two frame installation housings are available as a base unit:

- CPH 0006 A (for 6 modules) or
- MPH 0010 A (for 10 modules)

These housings can accommodate a panel controller with an operating and display unit.

The CPH 0006 A and MPH 0010 A basic housings can be extended to meet individual requirements using:

- EPH 0012 A extension housing for an additional 12 modules, frame installation
- PSF 0002 A or PMF 0004 power supply housing for two or four 12 V/45 Ah batteries respectively and an additional power supply unit.
- USF 0000 A Universal Housing Small, Frame Installation.

A power supply bracket for a UPS power supply is fitted ex-works in housing units CPH 0006 A, PSF 0002 A and PMF 0004 A.

Mounting Frames

All mounting frames have integrated terminal blocks for the mains supply, integrated junction boards, as well as permanently installed cable ducts to facilitate clear and tidy cable routing.

The mounting frames are available in three sizes:

- FBH 0000 A Mounting Frame Large
- FMH 0000 A Mounting Frame Medium
- FSH 0000 A Mounting Frame Small

The housings for frame installation require the following mounting frames for surface-mounted version:

Housing type	Mounting frames
CPH 0006 A	FBH 0000 A
MPH 0010 A	FBH 0000 A
EPH 0012 A	FBH 0000 A
PSF 0002 A	FSH 0000 A
PMF 0004 A	FMH 0000 A
USF 0000 A	FSH 0000 A

Notes:

- All mounting frames have an opening for routing cables that is sealed with an insert. Pre-punched cable entries can be created from this insert.
- The FBH 0000 A and FHS 0000 A mounting frames are equipped with an earth bar ex works.
- For the FMH 0000 A, the FPO-5000-EB Earth Bar can be ordered as an extension if required.
- For continuous installation in combination, all mounting frames have T-shaped guide rails on the base and T-shaped grooves on the top.

Mounting Plate

An HMP 0003 A Mounting plate can be mounted in large mounting frames FBH 0000 A and FHS 0000 A; this mounting plate can be individually equipped. It contains fixing holes for a distributor rail.

USF 0000 A is fitted with a mounting plate ex works, which can be equipped as required. It contains fixing holes for two distributor rails.

Equipment Limits

The table below shows the maximum number of:

- Modules
- Panel rails (short PRS-0002-C, long PRD 0004 A)

Housing type	Modules	Short rails	Long rails
CPH 0006 A	6	1	1
MPH 0010 A	10	1	2
EPH 0012 A	12	-	3
PSF 0002 A	-	-	-
PMF 0004 A	-	-	-
USF 0000 A	-	-	-

The table below shows the maximum number of:

- Panel controllers
- UPS power supply units
- Batteries

Housing type	Panel controller	UPS power supply units	Batteries
CPH 0006 A	1	1	2 x 45 Ah
MPH 0010 A	1	-	-
EPH 0012 A	-	-	-
PSF 0002 A	-	1	2 x 45 Ah
PMF 0004 A	-	1	4 x 45 Ah
USF 0000 A	-	-	-

Installation Kits for 48 cm (19") racks

Special installation kits are available for installing the frame installation housing in 482.6 mm (19") racks:

Housing type	Installation kit, 482.6 mm
CPH 0006 A	FRB 0019 A
MPH 0010 A	FRB 0019 A
EPH 0012 A	FRB 0019 A
PSF 0002 A	FRB 0019 A
PMF 0004 A	FRM 0019 A
USF 0000 A	FRS 0019 A

No mounting frame is required when using the 482.6 mm installation kits.

Scope of Delivery

Housing type	Scope of delivery (each x 1)
CPH 0006 A	- Housing, painted sheet steel - Power supply bracket - Sheet steel front panel with plastic cover - Accessories pack with installation material
MPH 0010 A	- Housing, painted sheet steel
EPH 0012 A	- Housing, painted sheet steel
PSF 0002 A	- Housing, painted sheet steel - Power supply bracket - Cable set for battery connection
PMF 0004 A	- Housing, painted sheet steel - Power supply bracket - Cable set for battery connection
USF 0000 A	- Housing, painted sheet steel - Mounting plate

2.5 Housings for wall mounting



Figure 2.4: Housings for wall mounting

Wall mounting housings are screwed directly onto the wall. This reduces the installation depth by approx. 9 cm, although the smaller 12 V/28 Ah batteries must be used as a result. The modular system makes it easy to extend the system.

Housing Designs and Combinations

Two wall mounting housings are available as a base unit:

- HCP 0006 A (for 6 modules), and
- HBC 0010 A (for 10 modules)

These housings can accommodate a panel controller with operating and display unit as the central element.

The HCP 0006 A and HBC 0010 A basic housings can be extended to meet individual requirements using:

- HBE 0012 A Modular Extension Housing for an additional 12 modules, and 2 x 12 V/28 Ah batteries
- PSS 0002 A or PSB 0004 A Power Supply housings for additional power supply units and 12 V/28 Ah batteries

Equipment Limits

The table below shows the maximum number of:

- Modules
- Panel rails (short PRS-0002-C, long PRD 0004 A)

Housing type	Modules	Short rail	Long rail
HCP 0006 A	6	1	1
HBC 0010 A	10	1	2
HBE 0012 A	12	-	3
PSS 0002 A	-	-	-
PSB 0004 A	-	-	-
DIB 0000 A	-	-	-

The table below shows the maximum number of:

- Panel controllers
- UPS power supply units
- Batteries

Housing type	Panel controller	UPS power supply units	Batteries
HCP 0006 A	1	1	2 x 28 Ah
HBC 0010 A	1	1	2 x 28 Ah
HBE 0012 A	-	1	2 x 28 Ah
PSS 0002 A	-	1	2 x 28 Ah
PSB 0004 A	-	1	4 x 28 Ah
DIB 0000 A	-	-	-

Installation Types

Various types of installation are possible:

- Surface mounted
- Installation in 482.6 mm (19") racks

For surface mounting, the housing is mounted directly on the wall. For installation in 482.6 mm (19") racks, the FRK 0019 A installation kit is used.

The housings have pre-formed cable bushings.

2.6 System overview

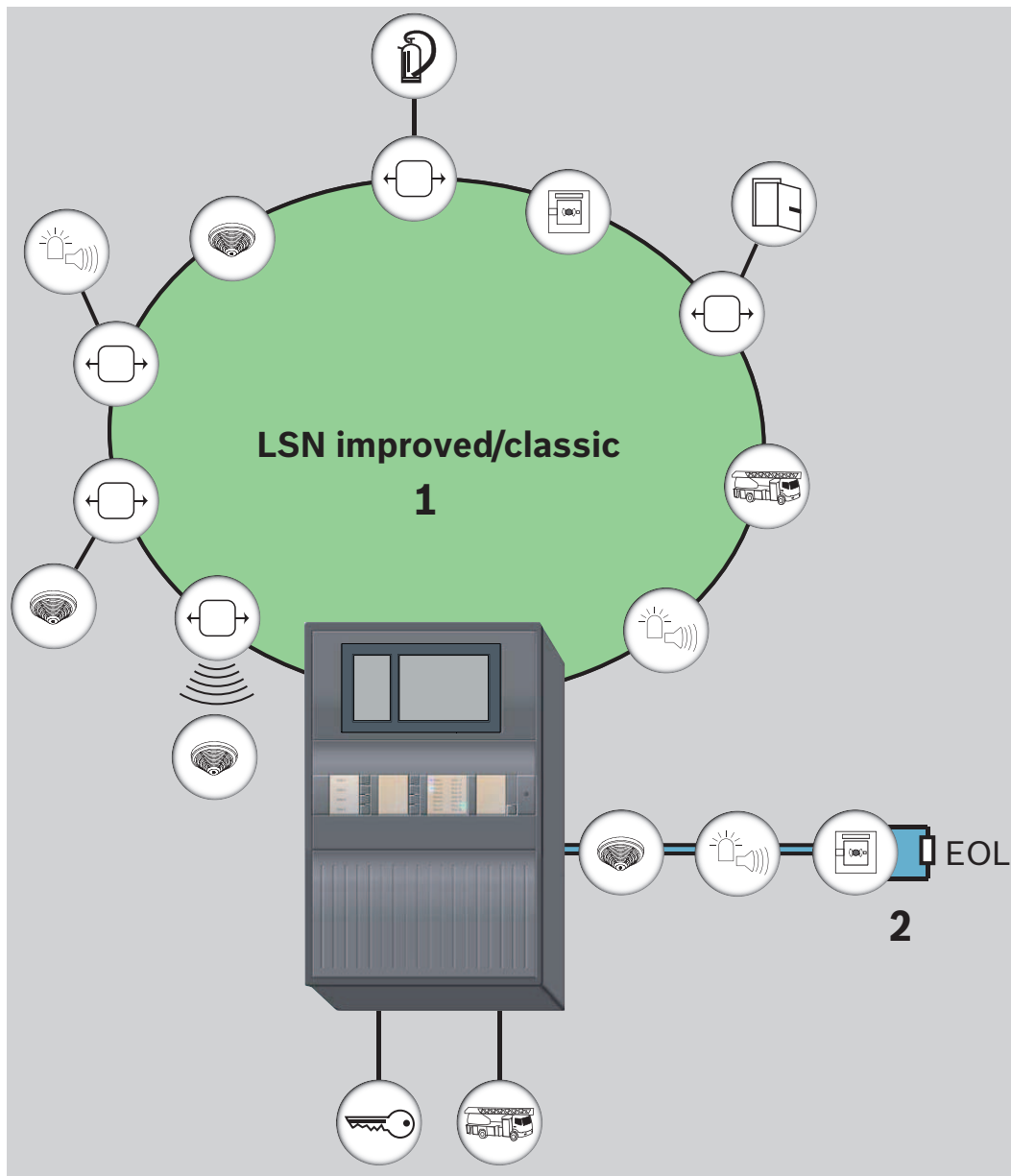





Figure 2.5: System overview with periphery

Position	Description
1	LSN loop (classic or improved version)
2	Conventional stub with EOL resistor or EOL module (optional: conventional loop)

The tables below list the various product groups with all compatible peripheral devices. The devices approved for connection to the CZM 0004 A Conventional Module or the FLM-420/4-CON Conventional Interface Module can be found in the relevant compatibility lists at www.boschsecurity.com.

Product group	Product name	Interface
Automatic fire detectors 	Point detectors	
	FAP-425/FAH-425 FAP-520	LSN 0300 A LSN 1500 A
	FCP-500 FCP-320/FCH-320	CZM 0004 A FLM-420/4-CON
	OOH740-A9-Ex	FLM-420/4-CON Connection with DCA1192/SB3
	Wireless smoke detectors and manual call points	
	FDOOT271-O FDM275-O FDM273-O	FWI-270
	Aspirating smoke detector	
	FAS-420-TM FAS-420-TP/-TT	LSN 0300 A LSN 1500 A
	FCS-320-TM FCS-320-TP	CZM 0004 A FLM-420/4-CON
	Linear smoke detectors	
	FIRERAY3000 FIRERAY5000	CZM 0004 A FLM-420/4-CON
	FRAY-ONE-EN	FLM-420-RHV
	Linear heat detectors	
	FCS-LHD-2EN	FLM-420-I8R1
	Infrared flame detectors	
	016519 016589	CZM 0004 A FLM-420/4-CON
	Duct smoke detectors	
	FAD-420-HS-EN	LSN 0300 A LSN 1500 A

Product group	Product name	Interface
Manual call points 	FMC-420RW FMC-210-DM FMC-210-SM	LSN 0300 A LSN 1500 A
	FMC-300RW FMC-120-DKM	CZM 0004 A FLM-420/4-CON
	DKM 2014/2-ex DM 1103 B-Ex	FLM-420/4-CON Connection with DCA1192/SB3

Product group	Product name	Interface
Notification appliances 	Audible and visual notification appliances	
	ROLP-LX	LSN 0300 A LSN 1500 A
	FNX-425U	LSN 0300 A LSN 1500 A
	Audible notification appliances	
	FNM-320	LSN 0300 A LSN 1500 A
	FNM-420 FNM-420U FNM-420V	LSN 0300 A LSN 1500 A
	PA 5 PA 10-SSM	FLM-420-NAC/NZM 0002 A
	Visual notification appliances	
	FNS-320 SOL-LX PY X-M-10-SSM	FLM-420-NAC/NZM 0002 A
	FNS-P400RTH	RMH 0002 A
	FNS-420-R	LSN 0300 A LSN 1500 A

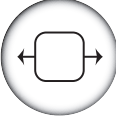
Product group	Product name	Interface
Interface modules 	ATB 420	LSN 0300 A
	ATG 420	LSN 1500 A
	BAT 100	
	FLM-420/4-CON	
	FLM-420-NAC	
	FLM-I 420-S	
	FLM-420-RHV	
	FLM-420-RLV1	
	FLM-420-RLV8-S	
	FLM-420-I8R1-S	
	FLM-420-I2	
	FLM-420-O2	
	FLM-420-O8I2-S	
	FLM-420-O1I1	
	FLM-420-RLE-S	
	FPP-5000-TI13	
	FWI-270	

Product group	Product name	Interface
Fire service devices 	FBF 100 LSN	Classic LSN only: LSN 0300 A LSN 1500 A
	FAT 2002 FAT 2002 RE (+ ADP-NB*)	FPE-5000-UGM + FLM-420-I2
	FMF-FAT/FMF-FBF-FAT FMF-FIBS	FMF-ADP-TTY FMF-ADP-TTY
	FMF-ESPA	FMF-ADP-TTY FMF-FAT/FMF-FBF-FAT FMF-FIBS
	*Included in the scope of delivery of the FAT 2002 RE	

Product group	Product name	Interface
Key deposits 	FMS-KR-BASIC FMS-KR-BASIC-RPF	ENO 0000 B

Product group	Product name	Interface
Door controls 	Automatic fire detectors	FAA-MSR 420
	FMD-GT60/FMD-GT50/FMD-GT50-SPACE	FLM-420-RHV
	TSZ 0400	FLM-420-I2

Product group	Product name	Interface
Power supplies	FPP-5000	FPP-5000-TI13
	FPP-3000 (ZSP135)	FLM-420-I2

2.7 Networking



Notice!

You will find detailed information about the CAN and Ethernet networking of the panels in the Networking Guide available for download at www.boschsecurity.com

2.8 Connection to BIS

The panel controller can be connected to a building management system (BIS) via an Ethernet connection and an OPC server.

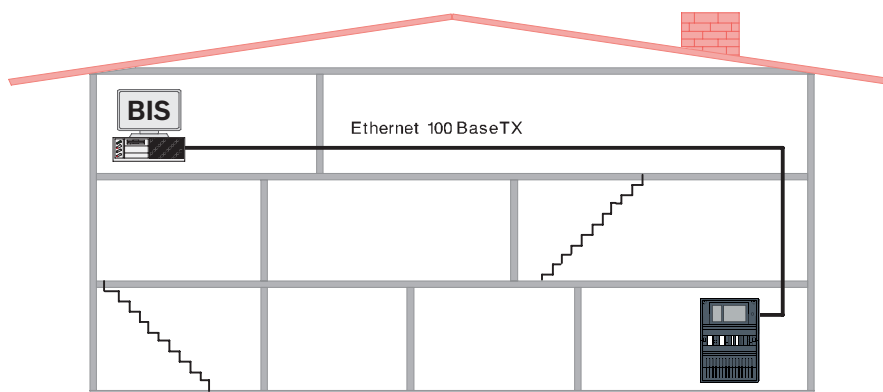

Figure 2.6: Connection to BIS

For a multiple-building network, it is essential to clarify with the network administrator:

- whether the network is designed for multiple-building connections (e.g. there must be no technical interference due to differences in grounding potential)
- whether the bus users are designed for this kind of network (e.g. sufficient bandwidth).



Notice!

For detailed information about the installation und configuration of the OPC server refer to the FSM-5000-OPC server manual.



Notice!

EN 54

The connection of a building management system (e.g. BIS) via an Ethernet interface using an OPC server or an FSI server is EN54 compliant if the EN54 relevant functions are performed by the fire panel solely. Any EN54 relevant control or administration (e.g. control of notification appliances or administration of switch-off) by the building management system requires an individual EN54 certification of the overall system by a certification body.

2.9

Connection to a voice alarm system

The PRAESENSA, Praesideo, PAVIRO or Plena voice alarm system can be connected via a data transmission line to the panel. This enables the panel to control voice alarm zones. The control can be defined down to the individual detector level.

- For connection to the PRAESENSA, Praesideo or PAVIRO systems the Ethernet interface and IP protocols are used. The voice alarm system can be configured for up to 244 virtual VAS triggers. You will find detailed information in the Networking Guide which is available for download at www.boschsecurity.com.
- For connection to a Plena system the RS232 interface on the IOS 0020 A or IOS 0232 A is used. The Plena system can be configured for up to 120 virtual VAS triggers. You will find detailed information in the Wiring Guide which can be found on the extranet.

The virtual VAS triggers are programmed using the FSP-5000-RPS programming software.

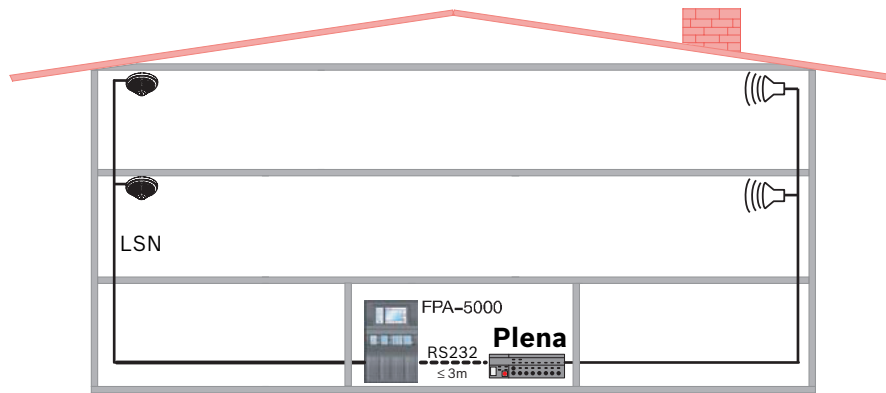

Figure 2.7: Connecting a Plena Voice Alarm System

3

Planning

Consider the following planning notes, and find details on several planning topics.

- Country-specific standards and guidelines must be considered during planning.
- The regulations issued by regional authorities and institutions (e.g. fire service) must be adhered to.
- Please note that standards and guidelines may require that a maximum of one function in more than one zone may fail.
For example, if the auxiliary power fails, only the fire detectors and/or manual call points of one zone may fail.
- We recommend the use of loops wherever possible, as they offer far greater security than stub lines.
- Terminating each stub and each T-tap with EOL modules is essential to set up a complete fire alarm system with extended line monitoring (creeping short circuit and creeping open monitoring).
- Conventional detectors of the Bosch portfolio for fire products can be connected using one of the following methods:
 - Using the CZM 0004 A 4 Zone Conventional Module
The module provides four DC primary lines (zones).
 - Using an FLM-420/4-CON GLT interface module on the LSN bus for two zones
- Consider the system limit for the number of LSN elements.
- Each element and input which is able to set off an alarm requires a detection point.
Inputs are considered as detection points if they are programmed accordingly using the FSP-5000-RPS Programming Software.
- In accordance with EN 54-2, no more than 512 detectors and their functions may fail if a system component fails.
- 12 V/45 Ah batteries can only be used with the frame installation housings.
- Use fuses complying with national regulations to protect the power lines.
- Recommended fire detector cable: J-Y(St)Y 2 x 2 x 0,8 mm, red.

Limits per functional module or interface module



Notice!

Safety Systems Designer can be used to plan fire alarm systems that conform to the relevant limits (e.g. in terms of cable length, power supply and energy requirement).

3.1 LSN modules

- It is possible to combine LSN interface modules, LSN detectors and notification appliances on one loop or stub line.
- For a mixed connection of LSN classic elements and LSN improved elements, a maximum of 127 elements are permitted.
- The use of unshielded cables is possible.
- Limits per LSN 0300 module:
 - Up to 127 LSN classic elements or 254 LSN improved elements can be connected
 - Current consumption of up to 300 mA
 - Cable length of up to 1600 m
- Limits per LSN 1500 module:
 - Up to 127 LSN classic elements or 254 LSN improved elements can be connected
 - Up to 1500 mA current consumption if LSN improved elements are connected
 - Up to 300 mA current consumption if LSN classic elements are connected
 - Cable length of up to 3000 m
- As stipulated by EN 54-2, panels with more than 512 detectors and manual call points must be equipped with a redundant panel controller. Combined with an AVENAR panel 8000, an AVENAR keypad 8000 can be used as a redundant panel controller.

3.2 Detection points

Each element or input that can trigger an alarm counts as a detection point. One stand-alone panel manages up to 4096 detection points. A panel operated in a network is limited to 2048 points.

All elements and inputs that do not use the Input type in the Message type setting are regarded as detection points. Therefore, all elements and inputs for which one of the following settings is programmed as the Message type are regarded as detection points:

- Fire
- Internal fire
- Supervisory
- Multi-criterion
- Smoke
- Fault
- Heat
- Water

Only some of these message types are available for selection depending on the element type. The elements and inputs that can trigger an alarm include all manual and automatic detectors, as well as the modules and interface modules listed below on the basis of the available inputs.

Modules	Detection Points
CZM 0004 A	Up to 4 (1 detection point per zone)
IOP 0008 A	Up to 8 (1 detection point per monitored input)
RMH 0002 A	Up to 2
ENO 0000 B	requires 1 detection point only if a FSE release element is connected and programmed using the FSP-5000-RPS programming software
FPP-5000-TI	2

Interface Modules Detection Points

FLM-420/4CON	Up to 2
FLM-420-I8R1	Up to 8
FLM-420-I2	Up to 2
FLM-420-O8I2	Up to 2
FLM-420-O1I1	Up to 1
FLM-420-RHV	Up to 2
FLM-420-RLE-S	Up to 2

3.3 Address setting

LSN elements are addressed via rotary switches (e.g. FAP 425-O-R) or DIP switches (e.g. E/W versions of the FLM-420). For setting addresses with DIP switches, refer to the instructions in the installation guide supplied with the product.

Address setting with rotary switches

The rotary switches can be used to select automatic or manual address setting with or without automatic detection:

Rotary switch setting	Address	Operating mode
	0 0 0	Loop/stub in LSN improved version mode with automatic addressing (T-tapping not possible) = factory default setting
	0 0 1 ... 2 5 4	Loop/stub/T-tapping in LSN improved version mode with manual addressing (address shown in example = 131)
	CL 0 0	Loop/stub in LSN classic mode with automatic addressing (T-tapping not possible, maximum number of elements = 127)

Table 3.2: Address setting with rotary switches

The rotary switches are moved to the required position using a slotted-head screwdriver.

Automatic Address Setting

If addresses are automatically allocated by a fire panel (LSN improved), all elements must have the address 0 0 0 (factory default setting).

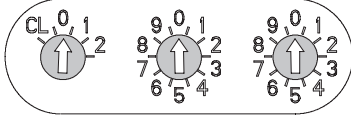
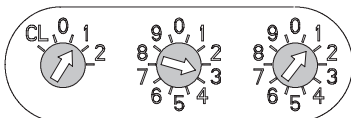
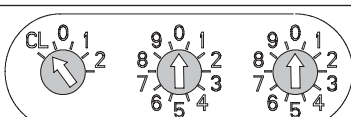
Manual Address Setting

With manual address setting, the address is set using the three rotary switches. The right-hand rotary switch is used to set the units, the central rotary switch is used to set the tens and the left-hand rotary switch is used to set the hundreds.

Manual address setting is required for T-tap topologies.

No matter what topology you set up: If you decide on manual address setting, then you have to select T-tap in FSP-5000-RPS.



Notice!

Using addresses greater than 254 is not permitted.

With manual address setting, all the detectors in a loop, stub or T-tap must have an address between 1 and 254.

3.4

Topologies in Local Security Network

Loop topology

Each LSN element provides a built-in isolator between the b1 and b2 connectors. The current flows through the LSN element between b1 and b2. With the return of the current to the LSN module the loop is formed. In normal operation, an LSN loop is powered alternately from one or the other side (LSN1/LSN2) of the loop, and direction of the current flow changes each 10 seconds.

LSN classic

In a Local Security Network (LSN classic), LSN elements can be configured as a loop or as one or two stubs. An LSN classic network allows a maximum of 127 elements.

LSN improved

An LSN improved network allows a maximum of 254 elements. With automatic address setting, LSN elements can be configured as a loop or as one or two stubs. With manual address setting, not only loop or stub, but also T-tap topologies are possible. As long as the maximum number of 254 elements is not exceeded, the LSN improved network allows branches anywhere along the LSN line, with any number of nodes, any number of branches per node and any number of elements per branch. Consider, that mesh structures are not allowed.

It is essential to ensure that no mesh structures are created.

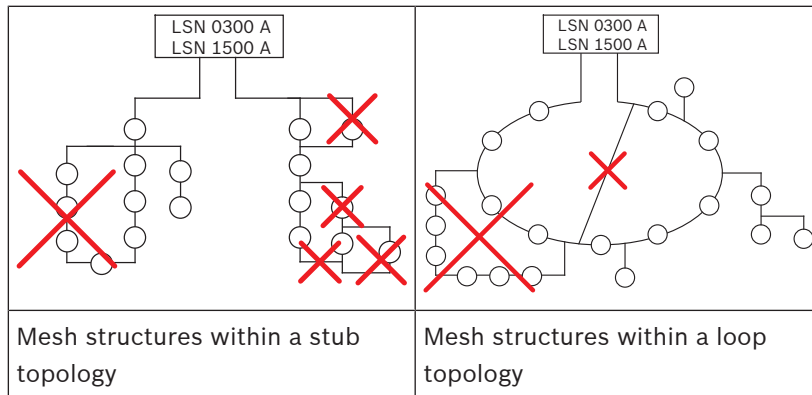

Table 3.3: Examples for not allowed T-tap topologies



Notice!

Planning should take the anticipated total current and line resistance into account to ensure each detector has an operating voltage of at least 15 V DC.



Notice!

In case of a bus fault, on stubs and branches no alternative way exists to reach an LSN element. Since in a loop topology each element can be reached on an alternative way for failure handling, prefer the loop topology.
 Consider that regional authorities may require an upper limit to the number of elements that can be lost due to a single fault.



Notice!

- From LSN module software version 1.0.35 onward, you can operate LSN improved elements and LSN classic elements in combination in a loop or in a stub.
- If an LSN classic element is present, only 127 elements can be used in the loop.
- T-tap topologies are only possible if only LSN improved elements are used. As soon as an LSN classic device is in a loop or stub, T-taps are no longer possible.

Topologies in LSN improved with automatic address setting

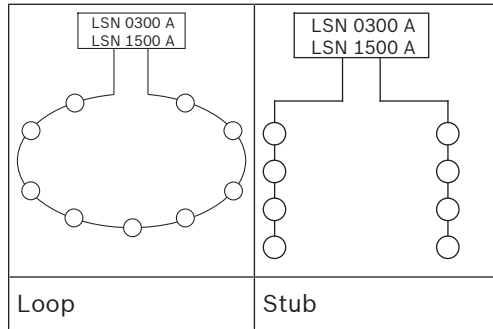

Table 3.4: Topologies in LSN improved with automatic address setting

Stub topology

Each LSN element provides a built-in isolator between the b1 and b2 connectors. The current flows through the LSN element between b1 and b2. Therefore, the last element of the stub has only incoming but no outgoing cable. Unlike for the loop topology, the direction of the current flow remains the same.

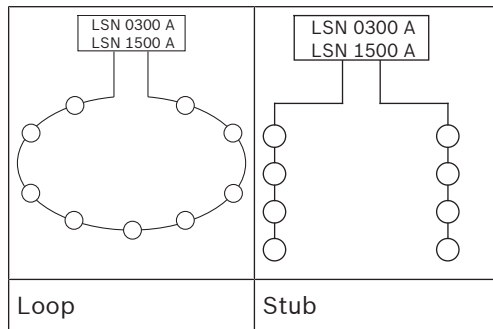

Table 3.5: Topologies in LSN classic

T-tap topology

In a T-tap topology one or several branches exist anywhere along the LSN line.

Topologies in LSN improved with manual address setting (T-tap)

		
Loop	Stub	
		
2 stubs with branches	Loop with branches	Loop with one-element branches

Table 3.6: Topologies in LSN improved with manual address setting (T-tap)

3.5

Failure handling in Local Security Network

Removal of LSN element

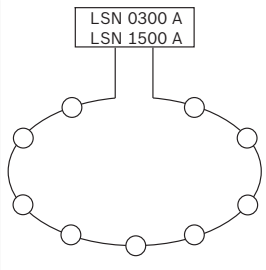
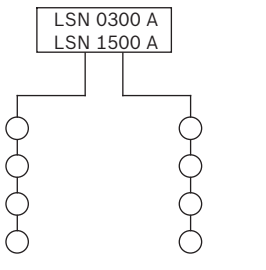
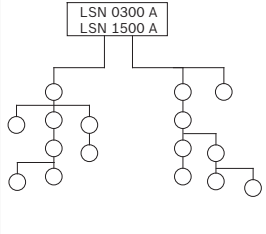
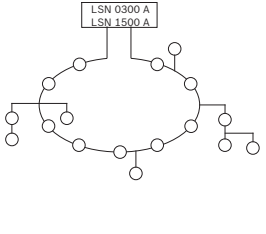
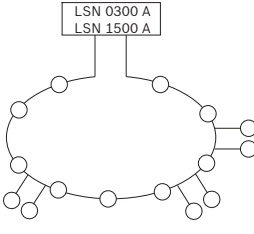
The removal of an LSN element also results in an open condition. During reinitialization the application functionality of all elements is interrupted. Therefore, the automatic reinitialization can affect the alarm timing of the devices.

Detector removal feature in T-tap topology

This feature ensures detector removal without affecting the alarm timing of other devices. The feature is based on prevention of reinitialization due to detector removal. The feature is available with LSN bus module firmware 1.0.55 and higher. In regions where local applicable standards require this feature, proceed as follows:

- Detectors whose removal should not affect the alarm timing of other devices must be installed as the last elements of T-tap stubs: Connect both the incoming and outgoing LSN b line to the b1 connector or connect both to the b2 connector. This will prevent a loop interruption when the element is removed. Since, it also prevents the element to act as an isolator, isolation must be ensured by the isolator in one of the other elements on the loop. In case of a short circuit condition, all non-isolated elements between the two isolating elements will be disconnected. The number of non-isolating elements between two isolating elements must thus be limited in number according to local regulations.
- Additionally, activate in FSP-5000-RPS under **Network Settings** the feature **Detector Removal Feature in T-Tap**.

Previously removed detectors can be reinserted back into their bases. After a reset of the LSN line the detectors will be restored to their normal function.

In case of a short circuit condition or an open condition, a loop topology offers for each unaffected LSN element an alternative way to keep up its application functionality. The LSN loop will be split. One resulting stub is powered by LSN1, the other resulting stub is powered by LSN2. The LSN line and the affected elements are in trouble status. An automatic reinitialization starts.

Unlike for the loop topology, you will lose all application functionality behind the element with short circuit or open condition in case of a stub or a branch.

Consider that the isolation function is limited if you use single-element branches on the LSN line. In a single-element branch the isolator function of the LSN element is not used: The b wires of the LSN line are only connected to one of the b connectors of the devices, e. g. b1. The LSN element will be powered through the b1 connector, and the current powering the remaining line is not passing through the element. The element thus does not act as an isolator. Each two neighboring isolating elements define a zone, and all elements within the zone will be affected in case of a short circuit fault within the zone. A short circuit will interrupt the application functionality in the zone.

Regional authorities may require an upper limit to the number of elements that can be lost due to a single fault. This limits the number of non-isolating elements that can be placed between two isolating elements.

**Notice!**

The Detector removal feature in T-tap topology should only be used if required by regional authorities.

If the independence of the alarm timing is not required, then use all isolators to reduce the number of detectors affected by a short circuit.

3.6

Redundancy

Standards and guidelines for example, DIN VDE 0833-2, EN 54-2 require different, country-specific redundancy conditions for specific applications:

- In the event of a system fault in the panel or the system, no more than 512 detectors may fail (EN 54-2). In such cases, redundant system components must be used:
 - Redundant panel controller
 - Redundant connection to a Bosch UGM
 - Redundant connection of the transmission device or AT5000 IP/GPRS IP/GPRS. Refer to the Wiring guide, which can be found on the extranet (access rights required).
- Activation of extinguishing systems in accordance with VdS 2496: If a signal processing unit fails, no more than one extinguishing area may fail. In such cases, redundant system components must be used:
 - Redundant panel controller
 - Redundant LSN 0300 A module when using more than one FLM-420-RLE-S in an LSN loop

For installation reasons, only 42 modules can be programmed when configuring a redundant panel. Without redundancy, 46 modules per panel are possible if one housing is set up with the panel controller and 10 modules and three housings each with 12 modules.

**Notice!**

In line with EN 54-2, a redundant panel controller must be used if there are more than 512 detectors connected.

3.6.1

AVENAR panel 8000 with panel redundancy

A second panel controller and a redundant cable set is required.

Refer to the Installation guide for FPE-8000-CRP Cable set redundant panel controller available for download at <https://www.boschsecurity.com>.

3.6.2 Remote keypad as redundant panel controller

In combination with an AVENAR panel 8000, standard or premium license, an AVENAR keypad 8000 can be used as a redundant panel controller. Only in this case the rail connector is needed.

A remote keypad and a cable set redundant keypad is required.

Refer to the Installation guide for FPE-8000-CRK Cable set redundant keypad, available for download at <https://www.boschsecurity.com>.

3.7 Achievable cable length with LSN 0300 A

The usable cable length depends essentially on the resistance of the cable and the quantity and current consumption of the network elements. The way in which the elements are distributed locally on the bus also makes a difference.

The possible cable length can be estimated using the formula below. This formula is also used in the Safety Systems Designer and is based on the critical application situation where all network elements are concentrated at the end of the bus line. The calculated cable lengths are therefore on the conservative side. The diagrams on *Using the Diagram for LSN classic, page 34* and *Using the Diagram for LSN classic, page 34* can be used to make a quick estimate.

$$L = \frac{q \times [U_0 - U_{END} - n_E \times R_{FET} \times (n_E/2 \times I_{NE} + I_{trans} + I_{flash}) + 1/2 \times R_{FET} \times (I_{trans} + I_{flash})]}{2 \times \rho \times (n_E \times I_{NE} + I_{trans} + I_{flash})}$$

The following applies:

L = cable length to be calculated in [m]

U₀ = bus voltage at the connection terminals = 30 volt

U_{End} = bus end voltage = 15 volt (must not fall below this limit!)

q = cable cross section = 0.503 mm² (for cable Ø 0.8 mm)

n_E = number of elements

ρ = specific resistance of copper = 0.0178 Ω mm²/m

R_{FET} = FET resistance = 0.7 Ω (LSN classic) or 0.35 Ω (LSN improved),

I_{NE} = average current consumption of elements in [A]

I_{trans} = transmission current = 0.012 A

I_{flash} = flash current = 0.018 A

Note that the sum of non-isolated cables must not exceed the limit of 500 m. The limit of 500 m applies to:

- The lines on the inputs of the following modules: FLM-420-RHV, FLM-420-I2 , FLM-420-I8R1-S, FLM-420-O8I2-S, FLM-420-O1I1, FLM-420-RLE-S
- The NAC line of the FLM-420-NAC module
- The lines to remote indicators: FAA-420-RI-DIN, FAA-420-RI-ROW

The limit of 500 m non-isolated cables doesn't count for the conventional lines of the FLM-420/4-CON and the lines connected to the relay contacts and open collector outputs.

Note that the maximum cable length must not exceed 1600 m.

Using the Diagram for LSN classic

FET resistance = 0.7 Ω, fire alarm cable with Ø 0.8 mm

Example 1:

You want to know the maximum cable length for a given number of network elements and a given current consumption (n_E = 50, I_{NE} = 3 mA). On the X axis, go vertically up at 50 until you reach the 3 mA curve. Then, from the point of intersection go horizontally to the left to the Y axis and read off the maximum achievable cable length. In this example it is 840 m.

Example 2:

You want to know the maximum number of network elements for a given cable length and an average current consumption of the network elements ($L = 1000 \text{ m}$, $I_{NE} = 20 \text{ mA}$). Starting from the Y axis at 1000, go horizontally across to the right as far as the 20 mA curve and then from the point of intersection vertically down to the X axis. Read off the maximum number of network elements, in this example it is 8.



Notice!

Remote indicators activated by the detector C point:
 A maximum additional cable length of 500 m is allowed when using remote indicators (e.g. FAA-420-RI-DIN/FAA-420-RI-ROW). The total length of installed cable must not exceed the limit of 1600 m.

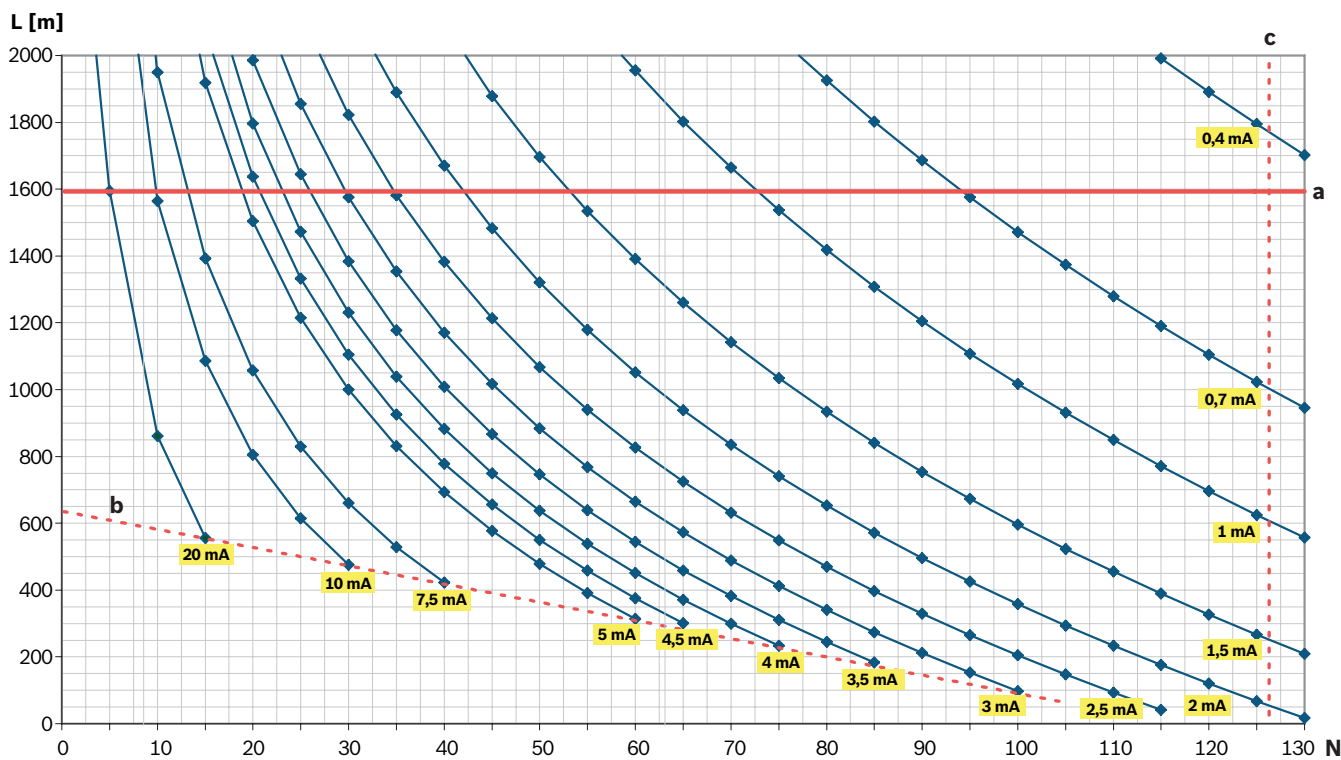

Figure 3.1: Diagram for determining the maximum achievable cable length: LSN classic elements with LSN 0300 A

- L = cable length in meters
- N = number of LSN classic elements
- a = 1600 m limit
- b = 300 mA limit
- c = maximum possible number of LSN classic elements = 127

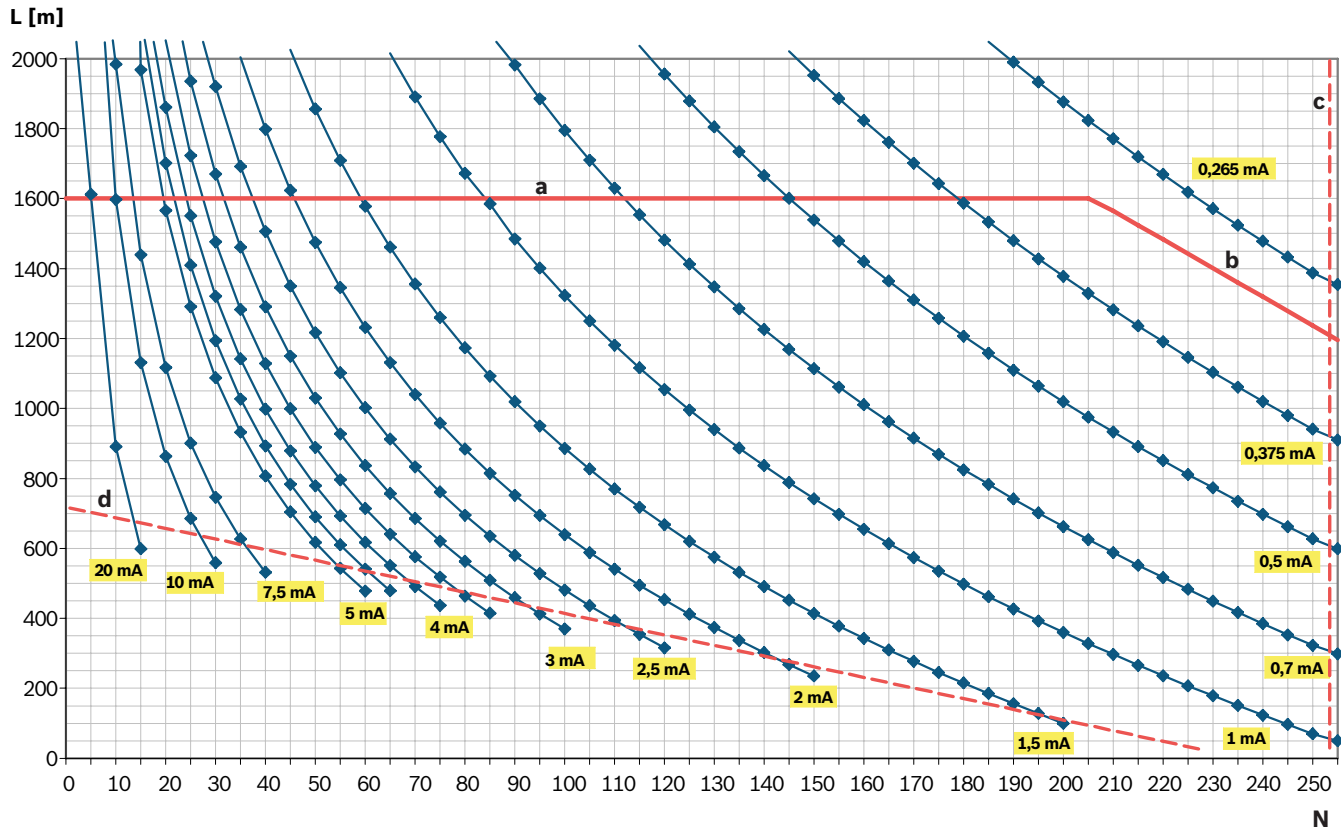

Figure 3.2: Diagram for determining the maximum achievable cable length: LSN improved elements with LSN 0300 A

- L = cable length in meters
- N = number of LSN improved elements
- a = 1600 m limit
- b = bus dynamic limit
- c = maximum possible number of LSN improved elements = 254
- d = 300 mA limit

3.8 Achievable cable length with LSN 1500 A

The usable cable length depends essentially on the resistance of the cable and the quantity and current consumption of the network elements.

The way in which the elements are distributed locally on the bus also makes a difference. The possible cable length can be estimated using the formula below. This formula is also used in the Safety Systems Designer and is based on the critical application situation where all network elements are concentrated at the end of the bus line. The calculated cable lengths are therefore on the conservative side.

The diagrams on pages *Using the Diagram for LSN improved, page 37* and *Using the Diagram for LSN improved, page 37* can be used to make a quick estimate.

$$L = \frac{q \times [U_0 - U_{END} - n_E \times R_{FET} \times (\frac{n_E}{2} \times I_{NE} + I_{trans} + I_{flash}) + \frac{1}{2} \times R_{FET} \times (I_{trans} + I_{flash})]}{2 \times \rho \times (n_E \times I_{NE} + I_{trans} + I_{flash})}$$

The following applies:

- L = cable length to be calculated in [m]
- U₀ = bus voltage at the connection terminals = 30 volt

U_{End} = bus end voltage = 15 volt (must not fall below this limit!)
 q = cable cross section = 0.503 mm² (for cable Ø 0.8 mm)
 n_E = number of elements
 ρ = specific resistance of copper = 0.0178 mm²/m
 R_{FET} = FET resistance = 0.7 Ω (LSN classic) or 0.35 Ω (LSN improved),
 I_{NE} = average current consumption of elements in [A]
 I_{trans} = transmission current = 0.012 A
 I_{flash} = flash current = 0.018 A

Note that the sum of non-isolated cables must not exceed the limit of 500 m. The limit of 500 m applies to:

- The lines on the inputs of the following modules: FLM-420-RHV, FLM-420-I2 , FLM-420-I8R1-S, FLM-420-O8I2-S, FLM-420-O1I1, FLM-420-RLE-S
- The NAC line of the FLM-420-NAC module
- The lines to remote indicators: FAA-420-RI-DIN, FAA-420-RI-ROW

The limit of 500 m non-isolated cables doesn't count for the conventional lines of the FLM-420/4-CON and the lines connected to the relay contacts and open collector outputs. Note that the maximum cable length must not exceed 3000 m.

Using the Diagram for LSN improved

FET resistance = 0.35 Ω, fire alarm cable with Ø 0.8 mm

Example 1:

You want to know the maximum cable length for a given number of network elements and a given current consumption ($n_E = 120$, $I_{\text{NE}} = 0.5$ mA). On the X axis, go vertically up at 120 until you reach the 0.5 mA curve. Then, from the point of intersection go horizontally to the left to the Y axis and read off the maximum achievable cable length. In this example it is 1950 m.

Example 2:

You want to know the maximum number of network elements for a given cable length ($L = 1000$ m, $I_{\text{NE}} = 2$ mA). Starting from the Y axis at 1000, go horizontally across to the right as far as the 2 mA curve and then from the point of intersection vertically down to the X axis. Read off the maximum number of network elements, in this example it is 73.



Notice!

Remote indicators activated by the detector C point:

A maximum additional cable length of 500 m is allowed when using remote indicators (e.g. FAA-420-RI-DIN/FAA-420-RI-ROW).

The total length of installed cable must not exceed the limit of 3000 m.

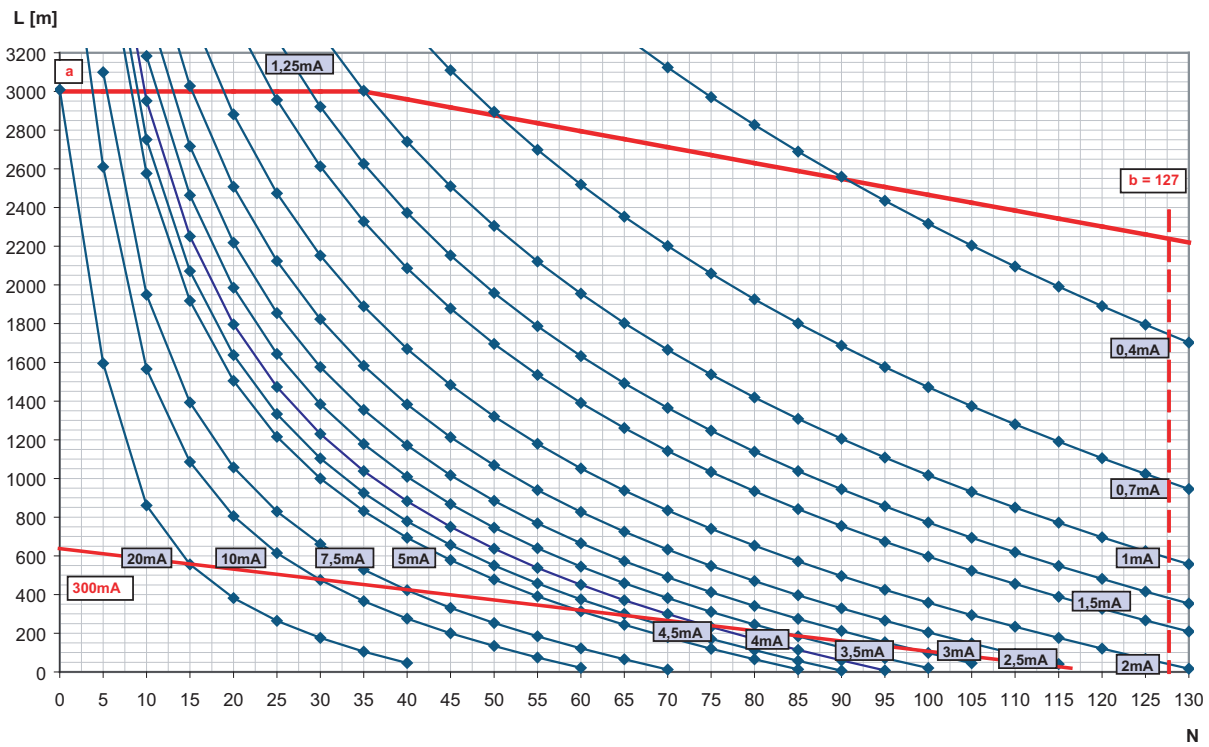

Figure 3.3: Diagram for determining the maximum achievable cable length: LSN classic elements with LSN 1500 A

L = cable length in meters

N = number of LSN classic elements

a = 3000 m limit

b = maximum possible number of LSN classic elements = 127

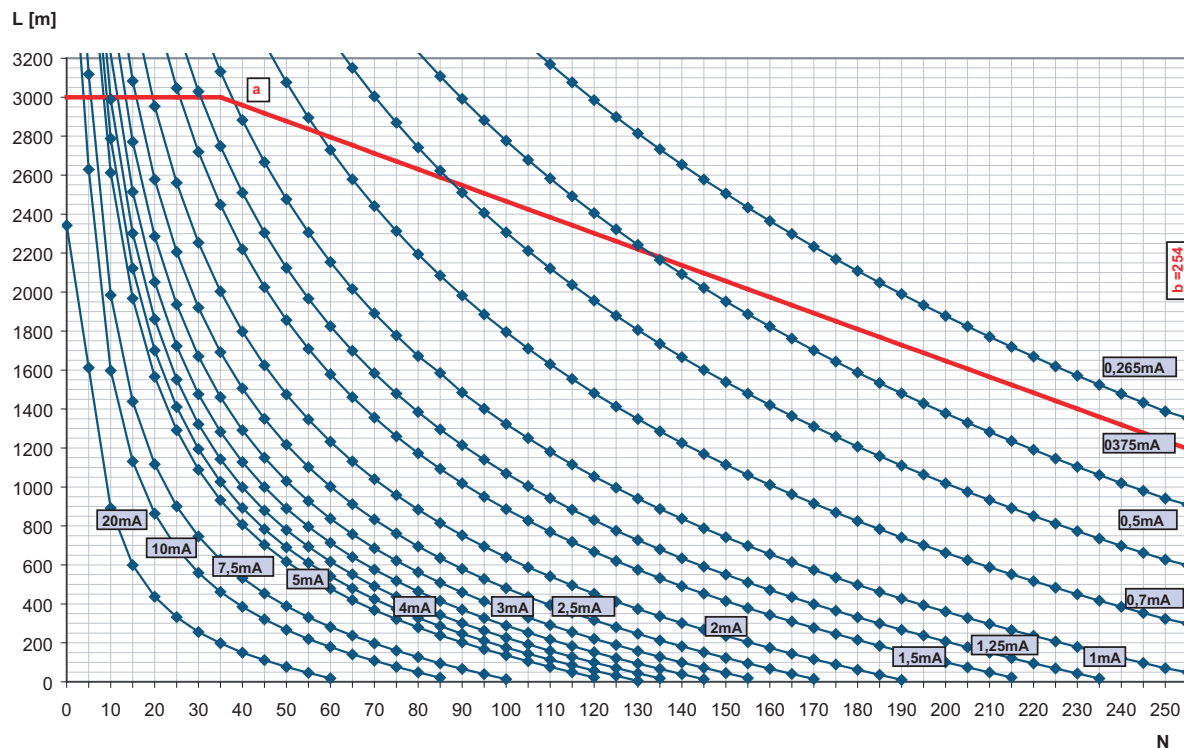

Figure 3.4: Diagram for determining the maximum achievable cable length: LSN improved elements with LSN 1500 A

L = cable length in meters

N = number of LSN improved elements

a = Bus dynamic limit

b = maximum possible number of LSN improved elements = 254

3.9 Configuration with BCM-0000-B modules

AVENAR panel 8000 can be powered by up to 8 BCM-0000-B battery controller modules, each with its own UPS 2416 A power supply unit. Current consumption is equally distributed among all battery controller modules.

Notes

- The 24 V switch outputs may not be connected in parallel.
- The total current for all connected components including the battery charge current may not exceed 6 A.
- The batteries connected to the BCM must all be of the same type and have identical electrical properties.
- The cable length at the switch outputs for faults may not exceed 3 meters.
- The cables for the switch outputs for faults may only be routed inside the housing.

Configuration with 1 to 4 BCM-0000-B modules in wall mounting housings

- Up to 2 BCM-0000-B modules on short panel rail
- Maximum 2 BCM-0000-B modules at the end of the long panel rail
- Each BCM-0000-B module requires one UPS 2416 A power supply unit.

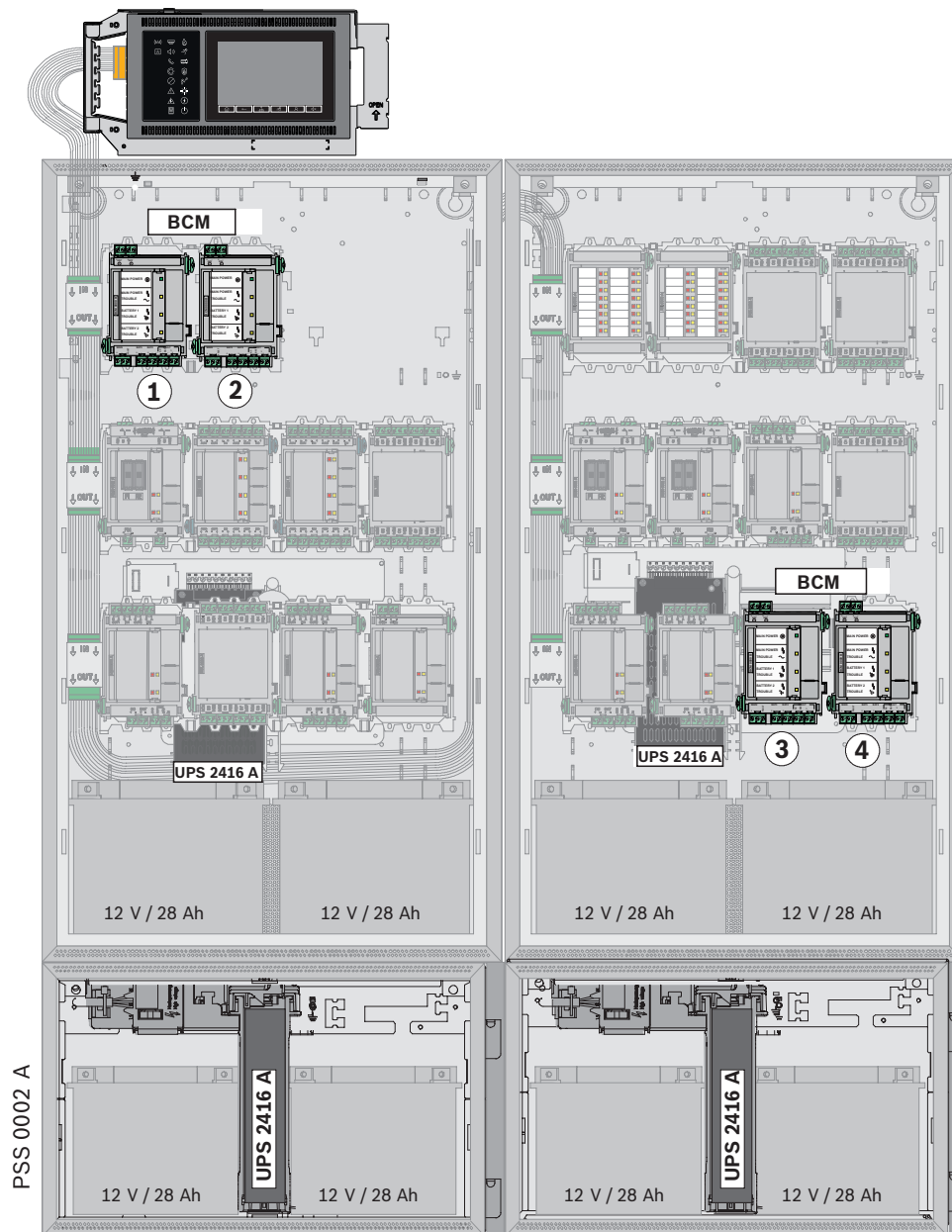

Figure 3.5: Configuration of 1 to 4 BCM modules (wall mounting)

Configuration with 1 to 4 BCM-0000-B modules in frame installation housings

- Up to 2 BCM-0000-B modules on short panel rail
- Maximum 2 BCM-0000-B modules at the end of the last long panel rail
- Each BCM-0000-B module requires one UPS 2416 A power supply unit.

Depending on the back-up time, a PMF 0004 A housing may be required instead of the PSF 0002 A housing for the power supply.

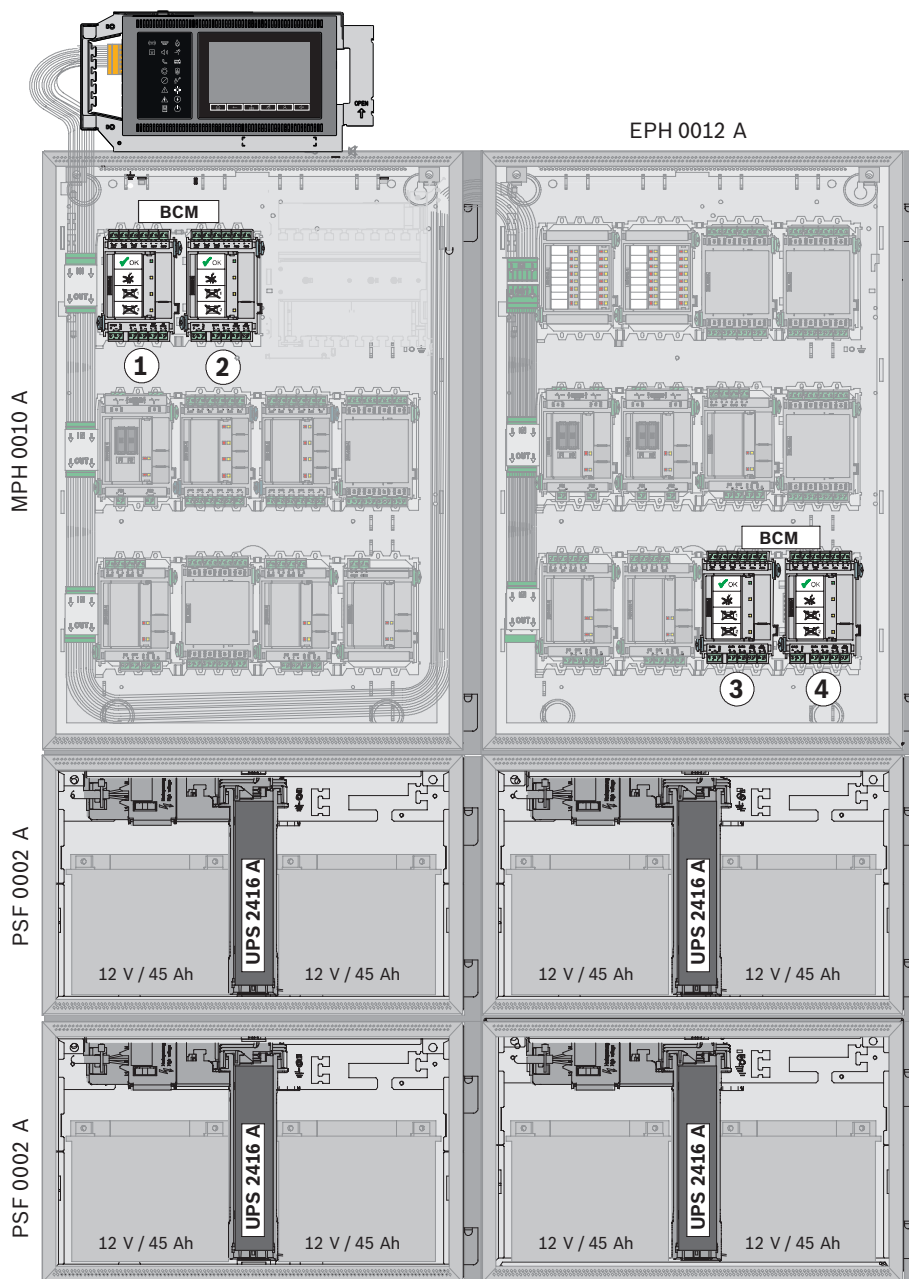

Figure 3.6: Configuration of 1 to 4 BCM modules (frame installation)

Configuration with 5 to 8 BCM-0000-B modules in wall mounting housings

- 2 BCM-0000-B modules on short panel rail
- 2 BCM-0000-B modules at the end of the long panel rail
- The remaining BCM-0000-B modules on a panel rail in the center of the system.
- Each BCM-0000-B module requires one UPS 2416 A power supply unit.

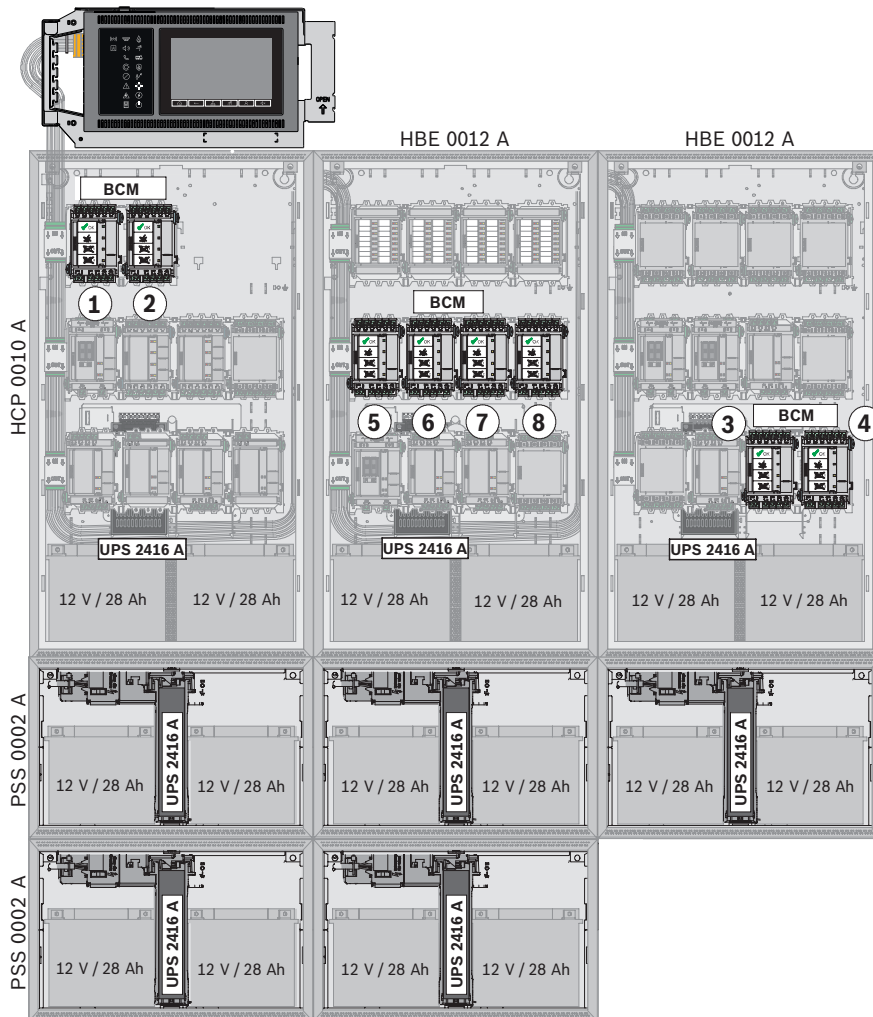

Figure 3.7: Configuration with 5 to 8 BCM-0000-B modules (wall mounting)

Limits:

The current load on a panel rail may not exceed the maximum value of 12 A.

The current load via a panel rail plug may not exceed the maximum value of 10 A.

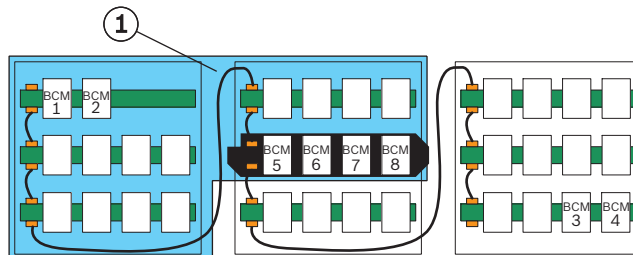

Figure 3.8: Area 1

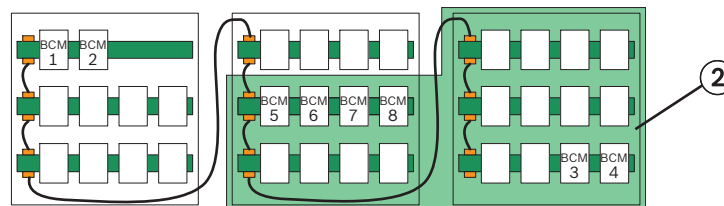

Figure 3.9: Area 2

Standby Current Calculation to EN 54-4

$$(1) I_{\max, \text{Standby}} = \frac{C_{\text{Batt}} - I_{\text{Alarm}} \times 0,5\text{h}}{t_{\text{Standby}}} \quad (2) I_{\max, A} = 6\text{A} - \frac{C_{\text{Batt}}}{18\text{h}}$$

$$(3) I_{\text{nom}} = \min[I_{\max, \text{Standby}}, I_{\max, A}]$$

Formula (1) describes the maximum system current to guarantee a particular back-up time ($I_{\max, \text{Standby}}$).

Formula (2) describes the maximum system current taking into account simultaneous battery charging ($I_{\max, A}$).

The system standby current (I_{nom}) to be selected is calculated from the lower of the two maximum system current values, as shown in the formula (3).

Parameters:

- t_{Standby} = back-up time in hours
- I_{Alarm} = maximum alarm current ($I_{\max, B}$)
- C_{Batt} = battery capacity in Ah

Possible capacities (C_{Batt}):

- 24 - 26 Ah or 36 - 45 Ah with 2 batteries
- 48 - 52 Ah or 72 - 90 Ah with 4 batteries

3.10**Protective earth and equipotential bonding**

Country-specific standards and guidelines must be considered, e.g. DIN VDE 0100-540, particularly with regard to the protective function of the electrical safety. These must be observed by qualified personnel.

- ▶ The UPS 2416 A power supply is a class I electrical appliance. Protection earth is required.
- ▶ Protective earth must be applied to the corresponding connection point of the copper rail in the mounting frame. The protective earth must have a safety connection to the electrical earth (ground). In addition to the protective function of the electrical safety, this also fulfills the functional requirements of protecting the system against interference voltages and electromagnetic disturbances.

4**Installation**

Consider the general information and follow the rough installation sequence. Subsequently you find two specific installation sequences:

- CPH 0006 A, fully configured panel
- HCP 0006 A, fully configured panel

For information on the installation of each component, refer to the Installation guide, which is included in the delivery and also available at www.boschsecurity.com.

4.1**General information****Warning!**

Live components and stripped cable! Risk of injury from electric shock. The system must be current-free during connection work.

**Warning!**

Electrostatic discharge.

The standard precautions for CMOS technology must be taken when handling PC boards.

**Warning!**

Risk of overheating

Bosch provides no front door for this system. You are not allowed to operate the system with a front door. Otherwise, the system can overheat, because the air vents are blocked.

- The fire panel may only be installed and commissioned by trained specialist personnel.
- Only use installation materials recommended by Bosch. Otherwise, interference resistance cannot be guaranteed.
- Connection conditions set down by the regional authorities and institutions (police, fire service) must be observed.

Environmental Conditions

- Assembly and operation of the fire panel must be carried out in a clean and dry indoor location.
- Permissible relative humidity: max. 95 % at 25°C, non-condensing
- To ensure optimum battery service life, the panel should only be operated at sites with normal room temperatures.
- Do not operate devices showing condensation.

Positioning

- Operating and display elements should be positioned at eye level.
The distance between the upper edge of the housing and the center of the panel controller display is around 11 cm. For example, if the eye level required is 164 cm, the housing upper edge installation dimension is 175 cm.
- For frame installation housings, a clearance of at least 230 mm is required to the right of the last housing to swivel out the installed housing (e.g. for connection, maintenance or service).
- Sufficient space should be left below and next to the panel for any possible extensions, e.g. for an additional power supply or an extension housing.

**Caution!**

EN 62368-1: MS 3. The installation height is recommended to a maximum of 2 m.

Functional Modules

- Functional modules are encapsulated; the connection terminals are protected against static discharge.

Building Management System

- If connected to a building management system (Bosch Building Integration System BIS) via an Ethernet interface using an OPC server, the following must be noted:
In a multi-building network, it is essential to clarify with the network administrator whether the network is designed for multi-building connections (e.g. no interference due to differences in grounding potential).

Documentation

- The current and full product documentation can be found at www.boschsecurity.com.
- For those with access rights, the current wiring guide can be found on the extranet. This contains information about the wiring of the functional modules and the peripheral devices.

- A printed short user guide in all relevant national languages with information on the most important functions on access level 1 and 2 is supplied with the panel controller. A detailed user guide containing all relevant information on operating and configuring the panel can be found at www.boschsecurity.com.

Store the documents in a safe place near the panel.

4.2 Installation sequence

1 Keep to hand:

- The installation instructions supplied with the relevant components (housing, frame, cables etc.)
- The required tools.

An overview of the required tools can be found in the installation instructions.

2 Preparation

- Lay the pre-cabling.
- Optional: network cabling.

3 Installation of housing

Installation of wall mounting housing

Install:

- Housing
- Optional: accessories for housing
- Power supply bracket
- Power supply unit and batteries
- Panel rail
- Panel controller
- Functional modules

Installation of frame installation housing

Install:

- Mounting frames
- Housing
- Optional: accessories for housing
- Power supply unit and batteries
- Panel rail
- Panel controller
- Functional modules

4 After installation

Store all documents.

4.3 Installation of CPH 0006 A, fully assembled panel

The installation sequence is given by the numbers 1 to 9.

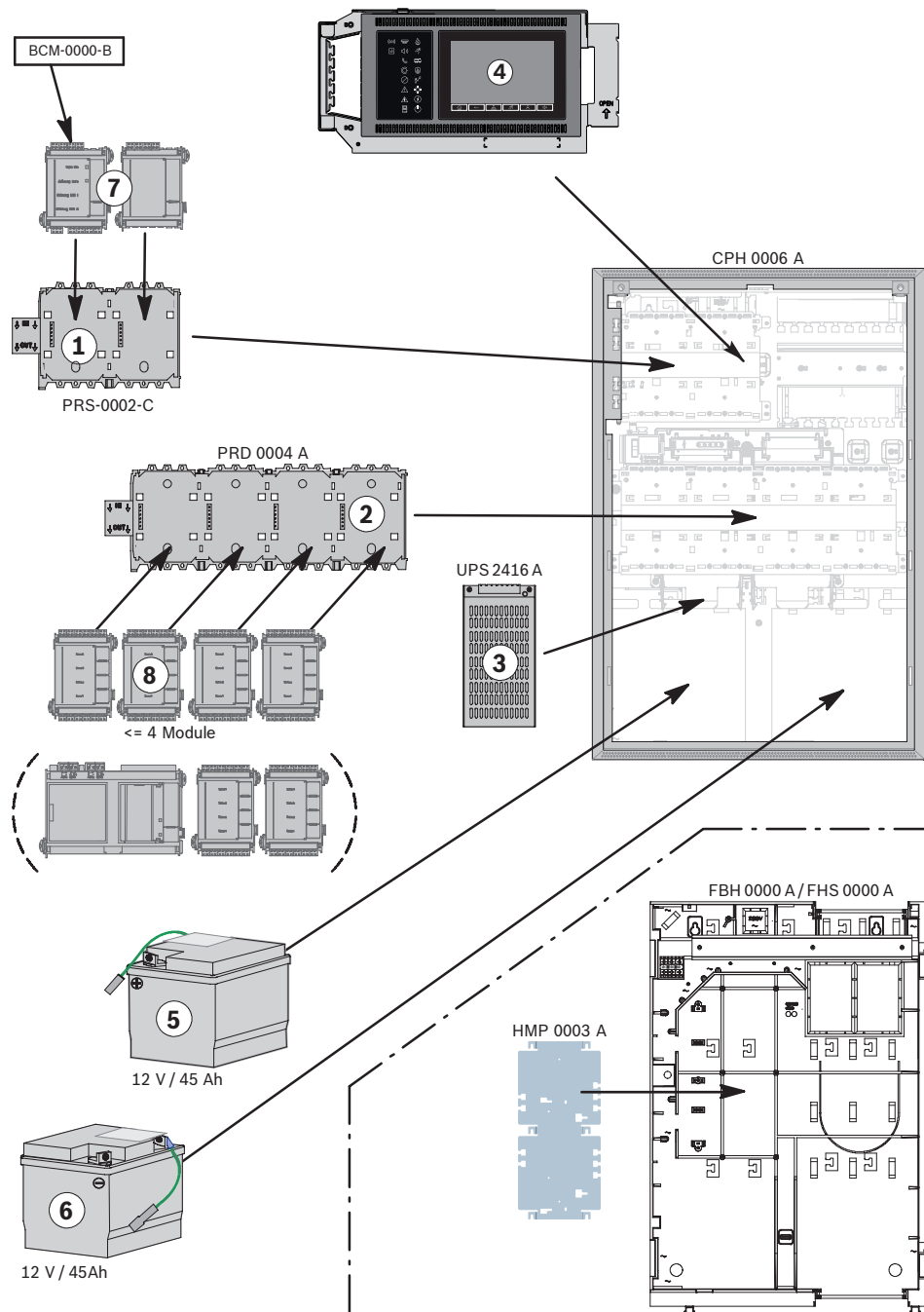

Figure 4.1: Installation of CPH 0006 A fully configured panel

4.4 Installation of HCP 0006 A, fully assembled panel

The installation sequence is given by the numbers 1 to 10.

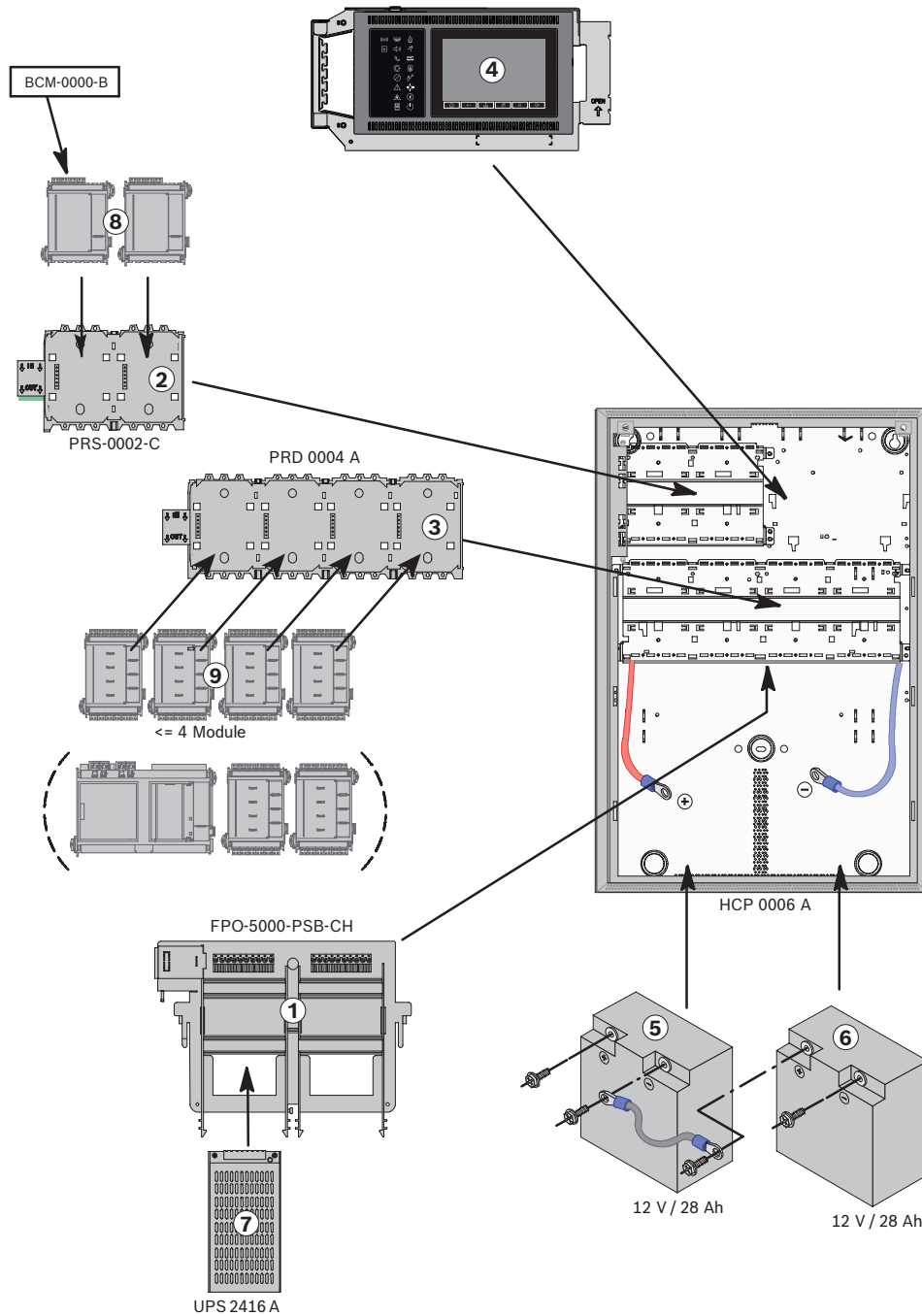

Figure 4.2: Installation of HCP 0006 A, fully configured panel

4.5 Extended line monitoring (VdS 2540, VdS 2543)

Auxiliary power supplies to the following modules can be monitored for creeping short circuits and creeping open: LSN 0300 A, LSN 1500 A, and BCM-0000-B (when using FPP-5000-TI13). A creeping short circuit is detected by these modules. An FPP-5000-TI13 forwards the faults detected and reported by the BCM-0000-B to the panel. Use additional 4-wire end of line elements to monitor for creeping open.

Procedure:

1. Monitor with 4-wire end of line element:
 - On stub cabling, terminate the exposed end of an AUX line with an FLM-420-EOL4W
 - Insert an FLM-420-EOL4W as the last element of an LSN ring or of a stub

- Use an FLM-320-EOL4W-S for the conventional zone of a conventional zone module or a FLM-420/4-CON
- 2. In FSP-5000-RPS, activate operation with extended line monitoring (formerly EN 54-13 requirement, now VdS 2540 and VdS 2543 requirement).



Notice!

VdS 2540, VdS 2543

For extended line monitoring (creeping short circuit and creeping open monitoring), no branch wiring is permitted for auxiliary power supplies.

4.6

FPP-5000 External Power Supply Unit Kit 24 V/6 A

The FPP-5000 External Power Supply Unit Kit is designed to provide a universal power supply, and has space for two 12 V/45 Ah batteries.

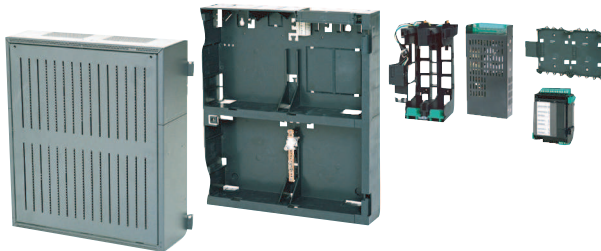

Figure 4.3: FPP-5000 External Power Supply Unit Kit 24 V/6 A

Scope of Delivery

- PMF 0002 A Power Supply Housing Frame Installation medium
- FMH 0000 A Mounting Frame Medium
- Power supply bracket, installed
- UPS 2416 A Universal Power Supply
- PRS-0002-C Panel Rail Short
- BCM-0000-B Battery Controller Module
- Requisite cable sets

Can be Extended with:

- 2 x 12 V/45 Ah batteries
- FPP-5000-TI Trouble Interface or FPP-5000-TI13 LSN Communication Interface
- FPO-5000-EB Earth Bar

Notes

- You can find the installation instructions for the FPP-5000 kit at www.boschsecurity.com by searching for the type designation (document number for installation instructions: F.01U.005.065).
- The installation dimensions are the same as those for the PMF 0004 A with FMH 0000 A Mounting frame.

FPP-5000-TI Trouble Interface

The FPP-5000-TI module is used in the FPP-5000 External Power Supply Unit with the BCM-0000-B to transmit faults to the fire panel via the Local Security Network (LSN).

Two independent signal inputs for "battery fault" and "mains current fault" allow a specified fault indication on the fire panel.

The FPP-5000-TI is connected directly to the LSN bus line and supplied with power via the bus line.

You can find the installation instructions for the FPP-5000-TI module at

www.boschsecurity.com (document number for installation instructions: F.01U.081.396).

The technical data can be found in FPP-5000-TI Trouble Interface.

FPP-5000-TI13 Communication Interface

The Communication Interface is an extension for the External Power Supply Unit Kit only. It is the communication interface between the External Power Supply Unit Kit and the panel, and transmits the following faults to the panel:

- Mains fault
- Battery fault
- Battery internal resistance fault
- BCM Battery Controller Module fault
- Short 24 V outputs
- Ground fault

Additionally, with the programming software, the switching outputs can be programmed and the settings for extended line monitoring can be done.

5 Commissioning

Notes

- Commissioning and the functional test may only be carried out by authorized specialist personnel.
- Observe all country-specific testing and acceptance regulations.
- A functional test must be carried out before commissioning.
Bosch recommends at least one functional test and one visual inspection per year.
- Follow the shut down procedure specified in the user guide, before removing the power from the panel or remote keypad.

Documentation

The current and full product documentation can be found at www.boschsecurity.com (Installation guides, System information, User guide).

The fire panel is configured on a PC using the FSP-5000-RPS programming software. The programming software and the associated documentation can be found at www.boschsecurity.com for those with access rights.

Information about the programming software is also included in the FSP-5000-RPS online help.

Guide for Commissioning

1. Connect the panel to the power supply.
2. Calibrate the touchscreen by pressing precisely on the cross-hairs.
3. Enter time, date, PNA (Physical Node Address), Ethernet Settings and reboot the panel.
4. Connect the panel controller to the PC (via USB). Make sure that the current version of the FSP-5000-RPS programming software is installed on your PC.
5. Start the auto-configuration. Edit the configuration according to the requirements of the fire alarm system.
6. Load the configuration to the panel controller.
7. Start the walktest.
8. Now go further with:
 - Testing the power supply
 - Testing the conventional and LSN functions
 - Testing the addressing/activation
9. Read out the diagnosis file and save the file as a test log.

5.1 Functional test

All components of the fire alarm system are installed and wired.

Switch on the fire panel by pressing the power button. The touchscreen calibration procedure will start automatically if necessary. For the initial setup of the panel, you have to enter time and date, physical node address, and Ethernet settings like redundancy and IP address. To make all changes effective you have to reboot the panel. For further information refer to the AVENAR panel series user guide.

1. Connect the laptop on which the FSP-5000-RPS programming software is installed to the fire panel.
2. Load the configuration.
3. Now go further with:
 - Testing the power supply
 - Testing the conventional and LSN functions
 - Testing the addressing/activation

5.1.1 Testing the power supply

1. Measure the voltage of the batteries.
The target values are 12.0 V to 14.1 V, or 24 V to 28.2 V.
2. Test the power failure function
Remove the fuse and make sure that the failure of the power supply is indicated on the display.
Make sure that the time limit for failure of the power supply is set to around 25min (in the configuration).
3. Restore the power supply.
Once the fire alarm system is reconnected to the power supply, it automatically goes into standby mode, and the power supply failure display disappears.
4. Test the battery failure function:
Remove the cables between the batteries and the BCM-0000-B module.
Make sure that the time limit for failure of the batteries is set to around 25min (in the configuration).
Indication of battery failure can be delayed by up to 15min.
5. Reconnect the cables between the batteries and the BCM-0000-B module.
Once the connection with the batteries has been restored, the battery failure display must be reset manually.

5.1.2 Testing the Conventional and LSN Functions

1. Testing a conventional/LSN loop:
Disconnect the conventional/LSN loop by detaching the cable connection to the corresponding functional module.
Failure of the conventional/LSN loop must be indicated on the display.
Restore the connection between the conventional/LSN loop and the corresponding functional module and reset the error message. Now test all automatic and manual detectors.
2. Testing a conventional/LSN stub:
Disconnect the conventional/LSN stub by detaching the cable connection to the corresponding functional module.
Failure of the conventional/LSN stub must be indicated on the display.
Restore the connection between the conventional/LSN stub and the corresponding functional module and reset the error message. Now test all automatic and manual detectors.

5.1.3 Testing the Addressing/Activation

1. Test the activation of the transmission devices (TD/DACT/TSN/GSM/X25/X31) by triggering the corresponding assigned detector.
2. Test the activation of the transmission devices (TD/DACT/TSN/GSM/X25/X31) by initiating the corresponding fault.
3. Test the activation of extinguishing systems, door controls etc.
4. Test all internal alarm signaling equipment (e.g. audible and visual notification appliances).

5.2 Panel controller firmware

A variety of firmware versions is available. Depending on the version number, a firmware is suitable for a certain hardware platform:

Panel	Controller	V1.x	V2.x	V3.x	V4.x
FPA-5000	MPC-xxxx-A	v	-	-	-
	MPC-xxxx-B	-	v	v	-
	MPC-xxxx-C	-	v	v	-
FPA-1200	FPA-1200-MPC	-	v	v	-
	FPA-1200-MPC-C	-	v	v	-
FMR-5000	FMR-5000-xx	-	v	v	-
	FMR-5000-xx-C	-	v	v	-
AVENAR panel 8000	FPE-8000-SPC	-	-	v	v
	FPE-8000-PPC	-	-	v	v
AVENAR panel 2000	FPE-2000-SPC	-	-	v	v
	FPE-2000-PPC	-	-	v	v
AVENAR keypad 8000	FPE-8000-FMR	-	-	v	v

Firmware version 2.x

It is strongly recommended to upgrade the FPA-5000 panel series to the latest firmware V3.x. After upgrading the MPC-xxxx-B / MPC-xxxx-C to firmware V3.x, the panel controller will not require any license and address cards. Additionally, the graphical user interface will change to match the AVENAR panel graphical user interface.

Firmware version 3.x

Firmware V3.x combines AVENAR panel series and FPA-5000 panel series in one panel network. This implies that when AVENAR panel and AVENAR keypad are running firmware V3.x, they only contain bound product features and peripheral devices that are also available with MPC-xxxx-B and MPC-xxxx-C panel controllers.

Depending on the hardware platform, firmware V3.x is available with two different file extensions:

- *.CBIN: MPC-xxxx-B and MPC-xxxx-C
- *.SWU: AVENAR panel and AVENAR keypad

Bosch recommends to upgrade the FPA-5000 panel series to the latest firmware V3.x.

**Notice!**

From January 1, 2022 to December 31, 2025, panel firmware version 3.x is in maintenance mode. During this period, new versions will be released containing fixes for critical bugs and critical security gaps. No new product features, LSN peripheral devices, GUI languages, and normative changes are planned to be added.

After December 31, 2025 running firmware V3.x on panels that are connected to an Ethernet interface or network increases security risks. It is strongly recommended to perform a security risk assessment. When security risks are identified, it is mandatory to upgrade to AVENAR panel and run latest firmware V4.x.

Firmware version 4.x

Firmware V4.x is exclusively for AVENAR panel and AVENAR keypad. From January 1, 2022, onwards, new product features, LSN peripherals, GUI languages, and normative changes will be only available in firmware V4.x. Firmware V4.x is only available with the extension *.SWU. To be future proof it is recommended to run the latest firmware V4.x when the system consists exclusively of AVENAR panel and AVENAR keypad.

Firmware update

To update the panel controller firmware, the *.CBIN and *.SWU files can be transferred to the matching panel controller through FSP-5000-RPS over the USB interface. Due to the file size, it is currently not possible to distribute the firmware over a panel network.

Additionally, it is possible to update AVENAR panel and AVENAR keypad using a memory card. Follow these steps:

1. Reboot the panel and open the boot menu by touching the touchscreen during reboot.
2. Copy the *.SWU file on the root folder of a memory card.
3. Insert the memory card into the slot of the controller.
4. In the boot menu, select **Load new firmware from memory card**.
5. Wait until the file is loaded and the system returns to the boot menu.
6. Select **Toggle Firmware and restart the panel**.
7. After restart, select the Bosch logo to verify the software version.

5.3

Storing trace files on a memory card

AVENAR panel has the option to store trace files on a memory card, for instance for an expert analysis when the system behaves unexpected.

To insert the memory card, follow these steps:

1. Get a FAT-32 formatted memory card.
2. Disable the write-protection of the memory card.
3. Insert the memory card in a computer.
4. If necessary, delete files from the card to maximize the capacity.
5. On the memory card, create a file named TRACE-AUTOSTART.
6. Remove the card from the computer.
7. Insert the memory card in the slot of the panel controller.
8. Let the system run for a period recommended by the technical support engineer.

**Notice!**

Do not remove the memory card while the panel is running. This could lead to corrupt trace files and incomplete trace information.

To remove the memory card, follow these steps:

1. Push and hold the power button shortly.

2. Wait until both green LEDs, **Power available** and **System in operation** are off.
The status LEDs, **General fault** and **Panel fault** are illuminated.
3. Remove the memory card from the slot.
4. Push the power button again to restart the panel.

To send the trace files to the technical support, follow these steps:

1. The SD-card contains one or more directories Pxxxxxxxxxxx where xxxxxxxxxxxx is an arbitrary hexadecimal number. Copy all these directories to the local hard disk of a computer.
2. Create an archive containing these directories, for instance zip or tar.gz.
3. Send the archive to the technical support.

**Notice!**

Do not remove or rename files.

6

Maintenance and service

In Germany, maintenance work and inspection work on security systems are governed by the regulations of DIN VDE 0833. These regulations stipulate reference to the manufacturer's instructions for maintenance intervals.

**Notice!**

Have maintenance and inspection work carried out regularly by trained, qualified personnel. Bosch recommends a functional and visual inspection at least once a year.

**Warning!**

Live components and stripped cable! Risk of injury from electric shock. The system must be current-free during connection work.

**Warning!**

Risk of overheating

Check regularly that ventilation gaps are not blocked by e.g. dust. Clean if necessary with a vacuum cleaner.

**Notice!**

Touchscreen recalibration is required to be performed at least once a year. Otherwise operating the device may be difficult or even not possible without prior re-calibration. For further information, see the necessary procedure in the user guide.

Clean the touch screen and surfaces with a slightly damp soft cloth only. Do not use any cleaning agents and make sure that no liquid enters the inside of the device.

Warranty

Defective devices are exchanged free of charge in the case of a claim under the warranty.

**Warning!**

Opening the controller or the modules can result in damaging the device. Opening the device will be recognized and results in the loss of warranty.

**Notice!**

Do not remove the security labels. This will void the warranty.

Repair

In the event of any defect, the entire device is exchanged.

Disposal

Unusable electrical and electronic devices must not be disposed of with normal household waste. They must be disposed of in compliance with the applicable regulations and directives (e.g. WEEE in Europe). See www.boschsecurity.com/xc/en/weee/ for further information.

Documentation

The installation instructions and operating instructions supplied with the device are available as PDF files at www.boschsecurity.com.

Additional documents (including the Wiring guide) are available to those with access rights at the extranet.

**Notice!**

The hexadecimal error codes can be found at the extranet (access rights required): LSN diagnostic data (F.01U.081.090).

**Warning!**

The power button must be used to switch off the device before removing the power supply. It may not be disconnected from power supply while system is running. The device may be damaged if this procedure is violated. Not following this procedure may result in loss of warranty. Refer to user guide for further information.

**Notice!**

The description of security item types can be found on the Extranet (access right required): Security item types (F.01U.353.668).

6.1**Replacement of FPA panel controller**

Due to its modular design and compatible architecture, an FPA fire panel can be upgraded with the latest AVENAR panel controller.

Consider the following checklist upfront:

Address cards

AVENAR panel does not require address cards.

- Make sure to order an AVENAR panel controller containing the right software license.
- Check if the fire panel has an interface to:
 - Building management system via BIS, OPC or FSI
 - Hierarchy panel (UGM-2040)
 - Voice alarm system (Smart Safety Link)
- A premium license is required for:

- A panel that needs to be available in a building management system or hierarchy panel
- A panel that is physically connected to a voice alarm system
- Concerning the detection points, no further action is necessary.
- After the replacement, the address cards can be disposed in compliance with the applicable local regulations and directives.

Short rail

- Use AVENAR panel controllers only in combination with the short rail PRS-0002-C.
- Exchange the short rail when the panel is equipped with a PRS 0002 A. Not exchanging the short rail will generate faults.

Battery controller module

- AVENAR panel cannot comply with EN 54-4 when the panel contains the legacy battery controller BCM-0000-A.
- Replace all BCM-0000-A by BCM-0000-B battery controller modules.

RS232 interface

AVENAR panel does not contain an integrated RS232 serial port anymore.

- Check if a device with an RS232 interface, for instance printer, is connected to the panel controller.
- When required, order an IOS 0232 A or IOS 0020 A.

Front door

Bosch provides no front door for AVENAR panel.

- Do not operate the system with a front door.
- Remove the front door before installing an AVENAR panel controller. Otherwise, the system can overheat because the air vents are blocked.

Redundant panel controller

- Always replace the master and slave panel controller when upgrading FPA-5000 with a redundant panel controller to AVENAR panel 8000. The panel will not work properly when an AVENAR panel and FPA-5000 panel controller are combined in one panel!
- When a premium license is required, make sure that the redundant panel controller contains a premium license as well. This way the interfaces to the building management system, hierarchy panel and voice alarm system will remain available when the slave panel controller takes over control.
- AVENAR panel 8000 is not compatible with the CRP 0000 A cable set. Use an FPE-8000-CRP cable set instead.
- The cable to the slave panel controller needs to be connected directly at the OUT of the last long rail.
- Do not use the second short rail anymore. Refer to installation guide for FPE-8000-CRP Cable set redundant panel controller.

Firmware and configuration

- The panel controller, which needs to be replaced, is perhaps still running on a firmware V1.x or V2.x.
- When AVENAR panel needs to be integrated in a panel network combined with FPA panel controllers type B and C, it is mandatory to use the compatible firmware V3.x. All panel controllers (AVENAR panel and FPA) need to be upgraded to an identical V3.x firmware.
- Use panel firmware V4.x when the system consists exclusively of AVENAR panel and AVENAR keypad.

To reuse the configuration, follow these steps:

1. Open FSP-5000-RPS.
2. Click with the right mouse button on the account.

3. Select **Upgrade to** followed by AVENAR panel V3.x or AVENAR panel V4.x.
4. It is recommend to select **Copy and Upgrade**.
A new firmware V3.x or V4.x account is created.
5. Open the configuration of the new account.
6. Select the nodes which are equipped with an AVENAR panel controller.
7. Change the node type to AVENAR panel and select **Apply**.
8. Load the configuration.
9. Perform a complete functional test of the system.

Battery autonomy

- Compared with an MPC-xxxx-C, an AVENAR panel controller has a slightly lower power consumption when configured with an identical configuration. In this case, the Ethernet ports 3 and 4 are not used and must be disabled in the configuration. Only in this case, the power battery autonomy remains on the previous level.
- To simplify the panel controller replacement, it is recommend not the change the Ethernet pattern. For instance keep the Ethernet switch in the panel and keep the OPC or FSI interface connected to the switch. Removing the switch or moving the OPC or FSI interface to Ethernet port 3 will result in a changed autonomy.
- When the configuration is not identical, certainly when Ethernet port 3 or 4 are used, it is mandatory to recalculate the battery capacity with the Safety Systems Designer.

Remote keypad

- When replacing a remote keypad, it is mandatory to replace all the plastic parts as well.
- For ease of installation, the dimensions of the flush mount bracket are identical to the previous version.

7 System limits

7.1 System limits AVENAR panel 8000

Panels/remote keypads/OPC servers in the network	Max. number
Ethernet / CAN	32

LSN elements	Max. number
Stand-alone panel	4096
Per network panel	2048
Total network	32768

Detection points	Max. number
Panel, without panel redundancy	512
Stand-alone panel, with panel redundancy	4096
Networked panel, with panel redundancy	2048
Total network	32768

NAC groups	Max. number
NAC groups with more than one FNM-420, per loop	6

Voice alarm system	Max. number
In CAN network, per panel (premium license)	1

Voice alarm system	Max. number
In total Ethernet network (premium license)	1
Triggers (each trigger counts as one sounder group) Ethernet interface	244
Triggers (each trigger counts as one sounder group) RS-232 interface	120
Per fire panel	Max. number
Sets, e.g. bypass group These sets include sets which are automatically created for each LSN bus.	192
Functional modules (with panel redundancy)	42
Functional modules	46
Printer	4
Alarm counters (external, internal, testing)	3
Entries in the event database	10000
FSP-5000-RPS configuration interfaces (USB)	1
Maximum number of outputs (sounders, controls, etc.) activated in parallel due to the same event	508
Configuration limits per fire panel (FSP-5000-RPS)	Max. number
Timer channels	20
Time control programs	19
Configuration for a Specific Day	365
Permission levels	4
User profiles	200
Sum counters and counters (in total)	60000
Exportable objects including counters in the entire panel cluster (without pre-defined system counters)	2000
Importable objects including counters (without pre-defined system counters)	2000
Automatic connections to remote keypad	3
Blocks of State-Dependent Rules (depending on what kind of activations are possible)	8
Maximum number of rules within a block	254
Number of functional modules	Max. number
ANI 0016 A	32
BCM-0000-B	8

Number of functional modules	Max. number
CZM 0004 A	32
ENO 0000 B	8
FPE-5000-UGM	4
IOP 0008 A	32
IOS 0020 A	4
IOS 0232 A	4
LSN 0300 A	32
LSN 1500 A	11
NZM 0002 A	8
RMH 0002 A	32
RML 0008 A	32

7.2

System limits AVENAR panel 2000

Panels/remote keypads/OPC servers in the network	Max. number
Ethernet / CAN (premium license)	32

LSN elements	Max. number
Stand-alone panel	1016
Per network panel	1016
Total network	32512

Detection points	Max. number
EN 54 compliant panel	512
Stand-alone panel, not EN54 compliant	4096
Networked panel, not EN 54 compliant	2048
Total network	32768

NAC groups	Max. number
NAC groups with more than one FNM-420, per loop	6

Voice alarm system	Max. number
In CAN network, per panel (premium license)	1
In total Ethernet network (premium license)	1
Triggers (each trigger counts as one sounder group) Ethernet interface	244
Triggers (each trigger counts as one sounder group) RS-232 interface	120

Per fire panel	Max. number
Sets, e.g. bypass group These sets include sets which are automatically created for each LSN bus.	192
Functional modules	6
Printer	4
Alarm counters (external, internal, testing)	3
Entries in the event database	10000
FSP-5000-RPS configuration interfaces (USB)	1
Maximum number of outputs (sounders, controls, etc.) activated in parallel due to the same event	508

Configuration limits per fire panel (FSP-5000-RPS)	Max. number
Timer channels	20
Time control programs	19
Configuration for a Specific Day	365
Permission levels	4
User profiles	200
Sum counters and counters (in total)	60000
Exportable objects including counters in the entire panel cluster (without pre-defined system counters)	2000
Importable objects including counters (without pre-defined system counters)	2000
Automatic connections to remote keypad	3
Blocks of State-Dependent Rules (depending on what kind of activations are possible)	8
Maximum number of rules within a block	254

Number of functional modules	Max. number
ANI 0016 A	4
BCM-0000-B	5
CZM 0004 A	4
ENO 0000 B	4
FPE-5000-UGM	4
IOP 0008 A	4
IOS 0020 A	4
IOS 0232 A	4
LSN 0300 A	4

Number of functional modules	Max. number
LSN 1500 A	0
NZM 0002 A	4
RMH 0002 A	4
RML 0008 A	4

7.3

Maximum number of devices per functional module or interface module

Module	Device	Max. number	Further information
CZM 0004 A FLM-420/4-CON	016519	1	
	016589	1	
FLM-420-NAC-D	PA 5	3	Used with FPP-3000
		2	Used with FPP-5000/BCM-0000-B
	PA 10-SSM	2	Used with FPP-3000
		1	Used with FPP-5000/BCM-0000-B
	PY X-M-10-SSM	1	Used with FPP-3000/FPP-5000/ BCM-0000-B
SOL-LX	10		
FMF-ADP-TTY FMF-ADP-FBF	FMF-FAT	4	
	FMF-FBF-FAT	4	
FLM-420-I8R1-S	FCS-LHD-2EN	1	Altogether only 200 LSN devices including max. 2 EOL modules on the same LSN bus No pre-alarm
LSN 0300 A LSN 1500 A	FLM-420-RLE-S	8	Max. number is valid for fire extinguishing systems
	FNX-425U	84/127	Up to 84 elements per loop Up to 127 elements per loop if operated without detector
	FWI-270	10	
	Any manual call point	21	
	FLM-420-EOL2W-W FLM-420-EOL4W	10	
FWI-270	FDOOT271-O FDM273-O FDM275-O	30	
NZM 0002 A	SOL-LX	11	1 Hz
		18	0.5 Hz

Module	Device	Max. number	Further information
	PA 5	2	
	PA 10-SSM	1	

7.4 Power loss of panel components



Notice!

Power loss of components (typical)

In the data sheet of the system you will find more detailed information on the listed typical power loss values.

Component	Power loss
ANI 0016 A	0.62 W (all LEDs lit)
BCM-0000-B	<ul style="list-style-type: none"> - 0.96 W (controller + green LED lit) - 1.44 W (per AUX with 1.06 A load)
CZM 0004 A	<ul style="list-style-type: none"> - 1.65 W (for a line with 100 mA load) - 3.36 W (for 4 lines with 100 mA load each)
ENO 0000 B	<ul style="list-style-type: none"> - 1.44 W (1 relay activated) - 7.80 W (4 relays activated + key deposit heating active)
FPE-2000-PPC	max. 10 W
FPE-2000-SPC	max. 10 W
FPE-5000-UGM	0.17 W
FPE-8000-FMR	max. 12 W
FPE-8000-PPC	max. 10 W
FPE-8000-SPC	max. 10 W
IOP 0008 A	0.24 W
IOS 0020 A	0.36 W
IOS 0232 A	0.36 W
LSN 0300 A	<ul style="list-style-type: none"> - 1.50 W (AUX with 490 mA load) - 2.72 W (LSN)
LSN 1500 A	<ul style="list-style-type: none"> - 8.00 W (AUX) - 14.70 W (LSN with 750 mA load)
NZM 0002 A	0.96 W
PRD 0004 A	0.07 W
PRS-0002-C	0.07 W
RMH 0002 A	1.16 W
RML 0008 A	1.04 W (all relays activated)
UPS 2416 A	28.00 W

7.5 FPP-5000 External Power Supply Unit Kit 24 V/6 A

For further information refer to the FPP-5000 installation guide.

8 Appendix

8.1 Options with requirements under EN 54-2:1997/A1:2006

The panel provides the following options with requirements under EN 54-2:1997/A1:2006:

- Output for activation of fire alarm devices
- Activation of fire alarm transmission equipment
 - Output to fire alarm transmission equipment
 - Alarm acknowledgement input from fire alarm transmission equipment
- Output for activation of fire protection equipment
 - Output type B
 - Output type C
 - Fault monitoring of fire protection equipment
- Transmission delay
- Dependency of fire detection status on more than one alarm signal
 - Type A dependency
 - Type B dependency
 - Type C dependency
- Alarm counter
- Fault signal status
 - Fault signals from detection points
 - Complete failure of power supply
 - Output to fault signaling transmission equipment
- Disabled status
 - Disabling of addressable points
- Test status
- Daymode status

8.2 Controlling Extinguishing Systems

The fire panel enables the activation of extinguishing systems with the extinguishing interface described in VDE 0833 Part 2 or by the VdS (standard interface SST in line with VdS 2496).

Connection occurs with the FLM-420-RLE-S Extinguishing module.

For each LSN loop, a maximum of 8 extinguishing systems can be activated in each case with an FLM-420-RLE-S Extinguishing module.

The requirement is for a maximum of one extinguishing area to fail in the case of a system fault. This means that from the second extinguishing area, there must be a redundant panel controller.

If several FLM-420-RLE-S Extinguishing modules are used to control the extinguishing system in each LSN loop, in addition to the redundant panel controller, the associated LSN 0300 A or LSN 1500 A module must also be duplicated.

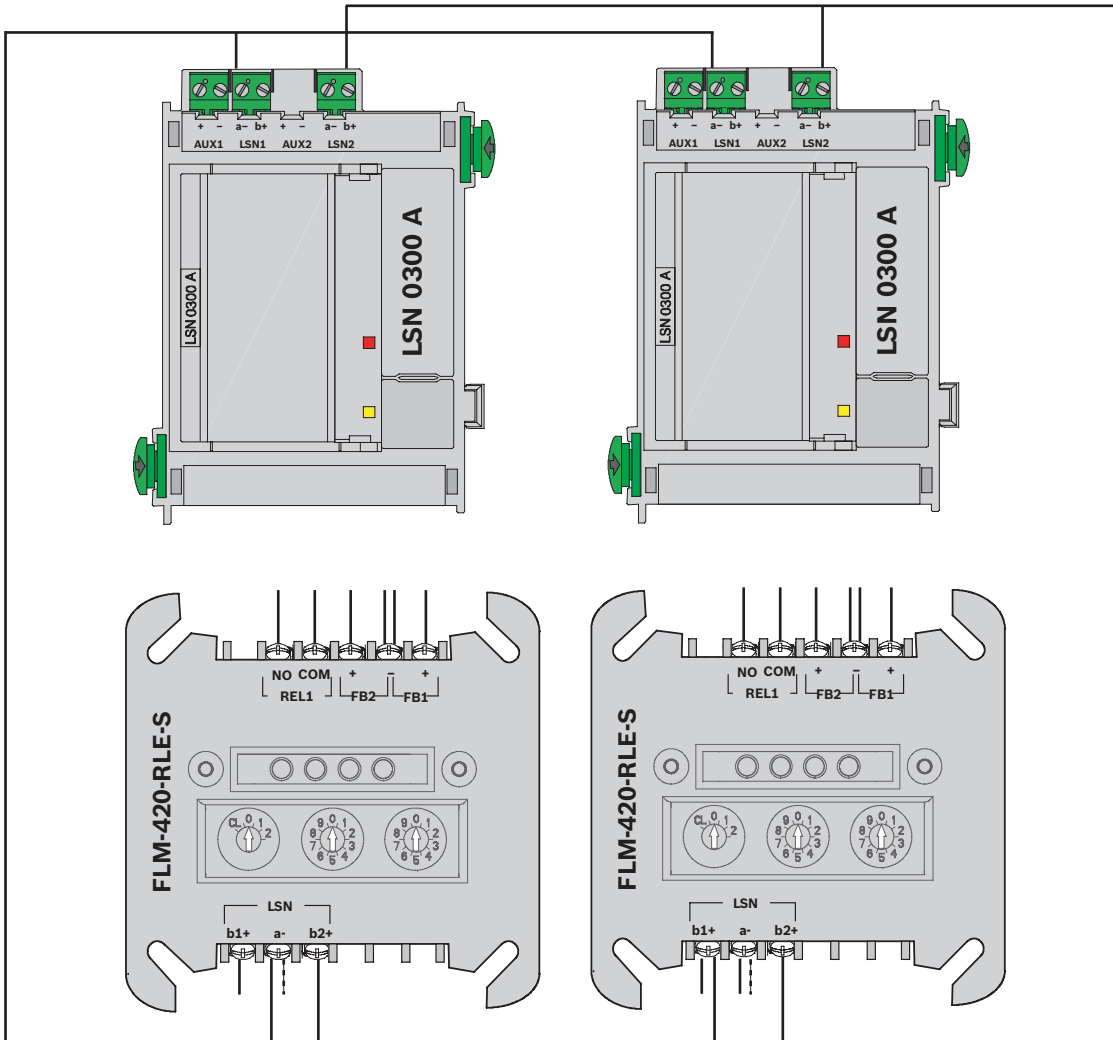

Figure 8.1: Several FLM-420-RLE modules in the LSN loop

8.3 Additional documentation

8.3.1 Frame installation housings, mounting frames and installation kits

Panel housings for frame installation

Designation	Installation manual ID
CPH 0006 A Modular Panel Housing for 6 Modules, Frame Installation	4998154002
MPH 0010 A Modular Panel Housing for 10 Modules, Frame Installation	4998154002

Extension housings for frame installation

Designation	Installation manual ID
EPH 0012 A Modular Extension Housing for 12 Modules	4998154002
PMF 0004 A Power Supply Big, Frame Installation	F01U003083
PSF 0002 A Power Supply Small, Frame Installation	F01U003083
USF 0000 A Universal Housing Small, Frame Installation	F01U003083

Mounting Frames

Designation	Installation manual ID
FBH 0000 A Mounting Frame Large	4998153998
FHS 0000 A Mounting Frame Large with Distributor Rail	4998154018
FMH 0000 A Mounting Frame Medium	4998153999
FSH 0000 A Mounting Frame Small	4998154000

48 cm (19") Installation Kits for Frame Installation Housing

Designation	Installation manual ID
FRB 0019 A Installation kit, large, 15 height units	4998154015_610
FRM 0019 A Installation kit, medium, 12 height units	4998154017_610
FRS 0019 A Installation kit, small, 6 height units	F01U003352_610

8.3.2**Wall mounting housings and installation kits****Panel Housings for Wall Mounting**

Designation	Installation manual ID
HBC 0010 A Modular Panel Housing for 10 Modules	4998153994
HCP 0006 A Modular Panel Housing for 6 Modules	4998153994

Extension Housings for Wall Mounting

Designation	Installation manual ID
DIB 0000 A Distribution Box	F01U003105_610
HBE 0012 A Modular Extension Housing for 12 Modules	4998153994
PSB 0004 A Power Supply	4998154010
PSS 0002 A Power Supply Small, Frame Installation	4998154010

48 cm (19") Installation Kit for Wall Mounting Housing

Designation	Installation manual ID
FRK 0019 A Installation kit	F01U005045

8.3.3**Accessories for housing****Mounting Plates/Installation Accessories**

Designation	Installation manual ID
FPO-5000-EB Earth Bar	F01U005061
HMP 0003 A Mounting Plate for Mounting Frame	F01U003791

Designation	Installation manual ID
RLE 0000 A Junction Board	F01U003090_610

Mounting Kits for Ethernet switch and media converter

Designation	Installation manual ID
FPM-5000-KES Mounting Kit for Ethernet Switch	F01U260523
FPM-5000-KMC Mounting Kit for Media Converter	F01U260524

8.3.4

Panel rails

Designation	Installation manual ID
PRD 0004 A Panel Rail Long, for up to 4 Modules	4998153989
PRS-0002-C Panel Rail Short, for up to 2 Modules	F01U284926

8.3.5

Power supply units

Designation	Installation manual ID
FPP-5000 External Power Supply Unit Kit	F01U005065
FPP-5000-TI Trouble Interface for FPP-5000	F01U081396
FPP-5000-TI13 LSN Communication interface for FPP-5000	F01U164562
UPS 2416 A Universal Power Supply 24 V/6 A	F01U003349
FPO-5000-PSB-CH Power Supply Bracket	F01U079870
FPO-5000-PSB1 Power Supply Bracket	F01U079868

8.3.6

Panel controller | remote keypad

Installation manuals **FPE-8000-FMR** and **FPE-2000-SPC** | **FPE-2000-PPC** | **FPE-8000-SPC** | **FPE-8000-PPC**

Designation	Installation manual ID
FPE-8000-FMR	F01U347558
FPE-2000-SPC panel controller, standard license	F01U347557
FPE-2000-PPC panel controller, premium license	F01U347557
FPE-8000-SPC panel controller, standard license	F01U347557
FPE-8000-PPC panel controller, premium license	F01U347557

User manuals FPE-8000-FMR and FPE-2000-SPC | FPE-2000-PPC | FPE-8000-SPC | FPE-8000-PPC

Designation	User manual ID
FPE-2000-SPC panel controller, standard license	F01U378877
FPE-2000-PPC panel controller, premium license	F01U378877
FPE-8000-SPC panel controller, standard license	F01U378877
FPE-8000-PPC panel controller, premium license	F01U378877
FPE-8000-FMR	F01U378877

8.3.7

Functional modules

Modules

Designation	Installation manual ID
ANI 0016 A Annunciator Module	4998153972_610
BCM-0000-B Battery Controller Module	F01U081382
CZM 0004 A 4 Zone Conventional Module	4998153977
ENO 0000 B Fire Service Interface Module	F01U063946
FPE-5000-UGM Interface Module	F01U028306
IOP 0008 A Input/Output Module	4998153976
IOS 0020 A 20 mA Communication Module	4998153974
IOS 0232 A RS232 Communication Module	4998153975
LSN 0300 A LSN improved Module 300 mA	4998153984
LSN 1500 A LSN improved Module 1500 mA	4998153983
NZM 0002 A Notification Appliance Zone Module	4998153982
RMH 0002 A Relay Module (for mains voltage)	4998153981
RML 0008 A Relay Module (for low voltage)	4998153973

Accessories

Designation	Installation manual ID
FDP 0001 A Dummy Cover Plate, for empty module slots	F01U003084

8.3.8

Cable sets

Designation	Installation manual ID
CBB 0000 A Cable Set BCM/Battery	F01U003099
CPB 0000 A Cable BCM/UPS	F01U003098
FPE-8000-CRP cable set	F01U357892

Index

Symbols

“Detector
Manual” 23

Numerics

4 Zone Conventional Module 27

A

Address Setting 29

Manual 29

Addressing

Automatic 29

Alarm indication 13

B

Battery controller module BCM
Configuration example 39

BCM Battery Controller Module 39

Plug load 42

Standby current 43

Building Management System 25, 44

C

Cable length 34, 37

CAN interface 6

Commissioning 49

Quick guide 49

Contact rating 42

Conventional Interface Module 27

Conventional module 22

CZM 0004 A 27

D

Detection point 27, 28

Detector 22

Automatic 23

Display 13

Disposal 54

Distributor rail 18

Documentation 44, 49, 54

Door control 25

E

EN 54-2, Requirements 62

EOL 27

Ethernet interface 6

Extinguishing systems, Activation 62

Extranet 26, 44, 54

F

Fire detector cable 27

Fire service

Devices 25

FLM-420/4-CON 27

FSP-5000-RPS Programming Software 7, 49

Functional module 9

Functional test 49

H

Height unit 64

Housing

frame installation 17

Installation types 21

Scope of delivery 19

Versions 6

Wall mounting 20

I

Installation 44

Documentation 44, 54

Instructions 44

Quick guide 45

Sequence 43

Installation kit, 482.6 mm 19, 64

Height unit 64

Interface modules 24, 25

Introduction 6

K

Key deposit 25

L

Limits 34, 37, 56, 58

Local Security Network, LSN 30, 34, 36

Cable length 34, 36

LSN module 28

M

Maintenance and service 53

Maximum limits 56, 58

Mounting frames 17

Mounting plate

Distributor rail 18

N

Networking 6, 13

Networking guide 26

Notification appliance

Audible 24

visual 24

Notification appliances 24

P

Panel controller 10

Panel rail 18

PAVIRO 26, 57, 58

Periphery	22
Planning	9, 27
Instructions	27
Software	9, 10, 27
Plena Voice Alarm System	26
Power loss	61, 000, 000, 000, 000, 000
Power supply	
External	48
Praesideo	26, 57, 58
R	
Redundancy	27, 28, 33
Keypad	34
Panel controller	33
Remote keypad	17, 34
S	
Safety Instructions	5
Safety Systems Designer	9, 10, 27
System limits	34, 37, 56, 58
T	
Technical data	
Power loss	61, 000, 000, 000, 000, 000
System limits	56, 58
Test	
Addressing/activation	51
Conventional/LSN functions	50
Power supply	50
Thermal printer	9
Touch screen	14
Trouble Interface	48
U	
Universal security system	7
V	
Voice alarm system	26, 57, 58
W	
Wiring guide	26, 44, 54

Bosch Sicherheitssysteme GmbH

Robert-Bosch-Ring 5

85630 Grasbrunn

Germany

www.boschsecurity.com

© Bosch Sicherheitssysteme GmbH, 2022

Building solutions for a better life.

202208111532